

T-piece

TCPUSS



Description

T-piece built with PSU saddle or a fully pressed top section.

The product is CE marked according to EN 12101-7 and used in a circular smoke control system - single compartment (see declaration of performance).

Dimensions

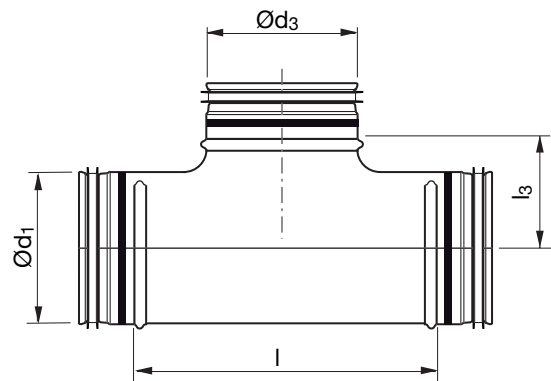
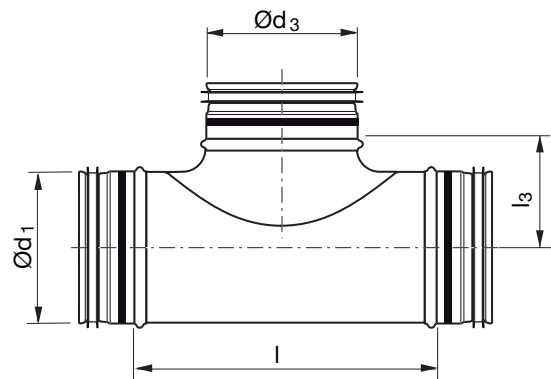

Ød ₁ nom	Ød ₃ nom	l mm	l ₃ mm	m kg
100	100	130	65	0,32
112	100	175	71	0,55
112	112 *	140	81	0,57
125	100	130	78	0,37
125	112	175	78	0,61
125	125	165	83	0,44
140	100	175	85	0,65
140	112	175	85	0,67
140	125 *	215	70	0,76
140	140	230	90	0,78
150	100	175	90	0,69
150	125	215	95	0,76
150	140	230	95	0,82
150	150	260	95	0,94
160	100	130	95	0,46
160	125	166	100	0,53
160	140	230	100	0,87
160	150	260	100	0,99
160	160	209	105	0,63
180	100	175	105	0,80
180	125	215	110	0,91
180	140	230	110	0,96
180	150	260	110	1,08
180	160	260	115	1,06

Ordering example



T-piece

TCPUSS

Ød ₁ nom	Ød ₃ nom	l mm	l ₃ mm	m kg
180	180	285	115	1,44
200	100	175	115	0,88
200	125	215	115	1,02
200	140	230	120	1,07
200	150	260	120	1,19
200	160	209	125	0,67
200	180	285	125	1,35
200	200	249	125	1,21
224	100	175	127	1,01
224	125	215	132	1,14
224	140	230	132	1,20
224	150	260	132	1,29
224	160	260	137	1,28
224	180	285	137	1,46
224	200	346	137	1,69
250	100	175	140	1,22
250	125	220	145	1,48
250	140	230	145	1,48
250	150	255	145	1,55
250	160	256	150	1,58
250	180	306	150	1,79
250	200	306	150	1,78
250	224	350	150	2,09
250	250	296	150	1,65
280	100	175	155	1,37
280	125	220	160	1,56
280	140	230	160	1,63
280	150	255	160	1,72
280	160	256	165	1,75
280	180	306	165	1,97
280	200	306	165	2,01
280	224	350	165	2,27
280	250 *	350	140	2,44
280	280 *	390	140	2,67
300	100	175	165	1,47
300	125	220	170	1,68
300	140	230	170	1,74
300	150	255	170	1,86
300	160	256	175	1,87
300	180	306	175	2,12
300	200	306	175	2,15
300	224	350	175	2,41
300	250	350	175	2,50
300	280 *	390	150	2,53
300	300	430	175	3,55
315	100	175	173	1,50
315	125	220	178	1,76
315	140	230	178	1,82

Ød ₁ nom	Ød ₃ nom	l mm	l ₃ mm	m kg
315	150	355	178	2,38
315	160	256	182	1,96
315	180	306	182	2,21
315	200	306	182	2,14
315	224	350	182	2,51
315	250	350	182	2,59
315	280	390	182	3,00
315	300	430	182	3,21
315	315	363	182	2,20
355	100	175	193	1,73
355	125	220	198	1,96
355	140	230	198	2,03
355	150	255	198	2,46
355	160	256	203	2,45
355	180	306	203	2,81
355	200	306	203	2,82
355	224	350	203	3,13
355	250	350	203	3,18
355	280 *	390	178	3,63
355	300	430	203	3,87
355	315	455	203	4,06
355	355 *	470	203	5,14
400	100	175	215	2,27
400	125	225	220	2,81
400	160	266	225	3,02
400	200	300	225	3,37
400	224	350	225	3,74
400	250	350	225	3,79
400	280 *	390	200	4,23
400	300	430	225	4,47
400	315	415	225	4,42
400	355 *	470	225	5,04
400	400	510	225	6,20
450	100	175	240	2,76
450	125	225	245	3,15
450	160	266	250	3,38
450	200	300	250	3,75
450	224	350	250	4,16
450	250	350	250	4,23
450	280 *	390	225	4,64
450	300	430	250	4,89
450	315	415	250	4,82
450	355	470	250	5,16
450	400	510	250	5,81
450	450 *	550	225	6,99
500	100	175	265	3,06
500	125	225	270	3,35
500	160	266	275	3,77

T-piece

TCPUSS

Ød ₁ nom	Ød ₃ nom	l mm	l ₃ mm	m kg
500	200	300	275	4,14
500	250	350	275	4,68
500	300	430	275	5,36
500	315	415	275	5,30
500	355	470	275	5,70
500	400	510	275	6,34
500	450 *	550	250	6,56
500	500 *	552	290	8,27
560	100	175	295	3,59
560	125	225	300	3,92
560	160	266	305	4,41
560	200	300	305	4,78
560	250	350	305	5,38
560	300	430	280	5,86
560	315	415	305	6,06
560	355	470	305	6,57
560	400	510	305	7,08
560	450 *	550	280	7,38
560	500 *	552	280	7,57
560	560 *	610	280	9,69
600	100	175	315	3,83
600	125	225	320	4,19
600	160	266	325	4,73
600	200	300	325	5,10
600	250	350	325	5,73
600	300 *	430	300	6,36
600	315	415	325	6,46
600	355 *	470	300	6,98
600	400	510	325	7,43
600	450 *	550	300	7,84
600	500 *	552	300	7,91
600	560 *	610	300	8,76
600	600 *	650	300	10,8
630	100	175	330	4,03
630	125	225	335	4,41
630	160	266	340	4,99
630	200	300	340	5,35
630	250	350	340	6,00
630	300 *	450	315	7,23
630	315	415	340	6,77
630	355 *	470	315	7,18
630	400	510	340	7,69
630	450 *	555	315	8,24
630	500 *	552	340	8,44
630	560 *	610	315	9,11
630	600 *	650	315	9,58
630	630 *	680	340	11,3

* Hand made with saddle without radius.

T-piece and saddle

TCPUSS

Supply air

Diverging flow

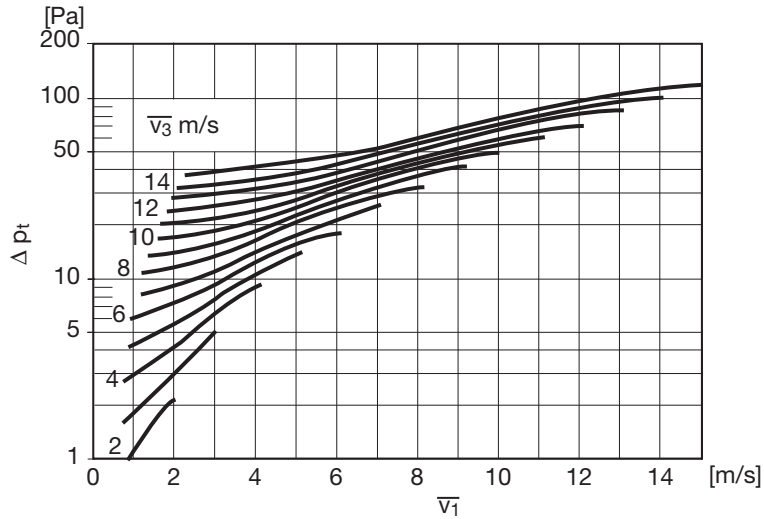
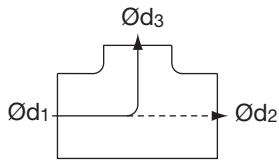

Diverging flow

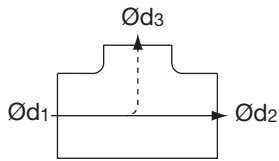

The diagram is also applicable to reduction in Ød_2 .

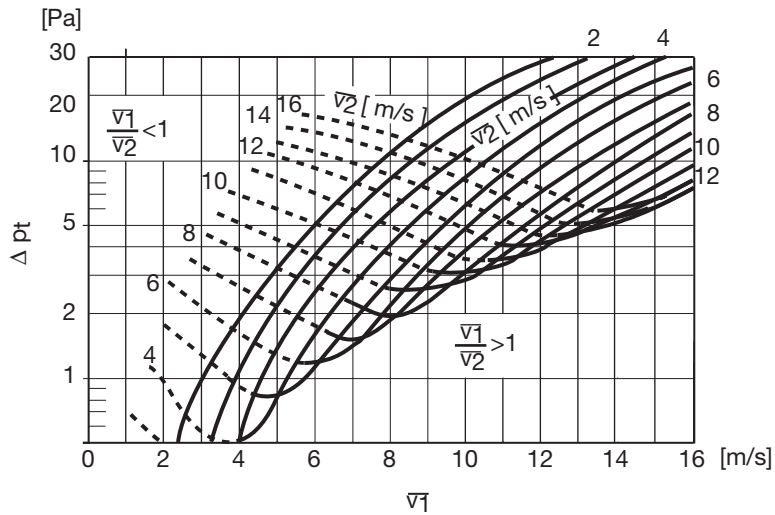

Diverging flow

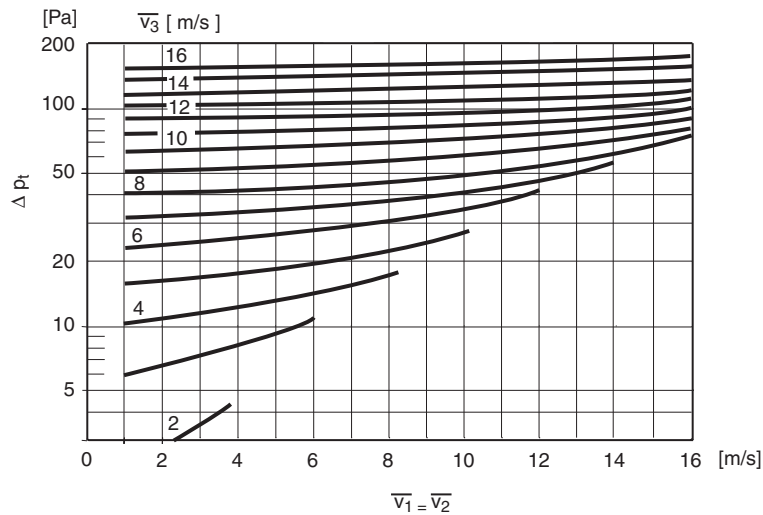
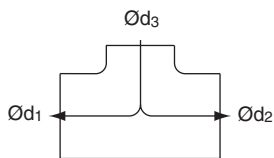

T-piece and saddle

TCPUSS

Exhaust air

Converging flow

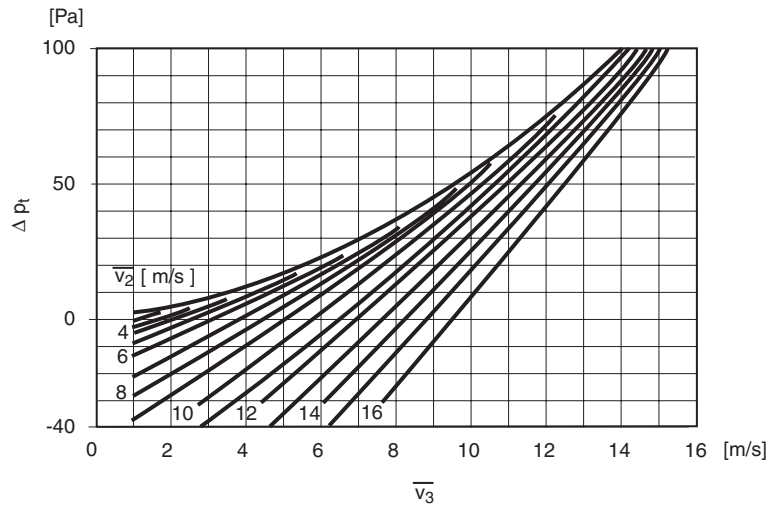
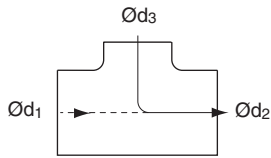

Converging flow

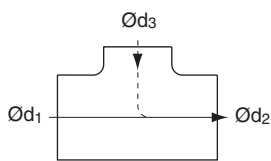

The diagram is also applicable to reduction in $\varnothing d_1$.

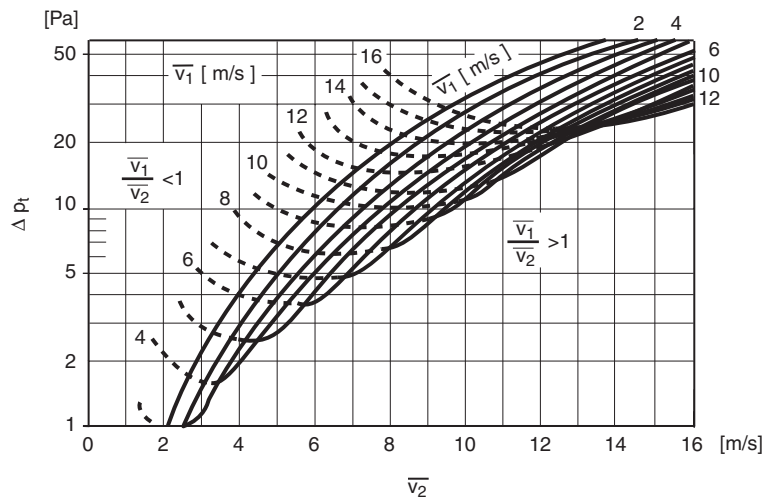

Converging flow

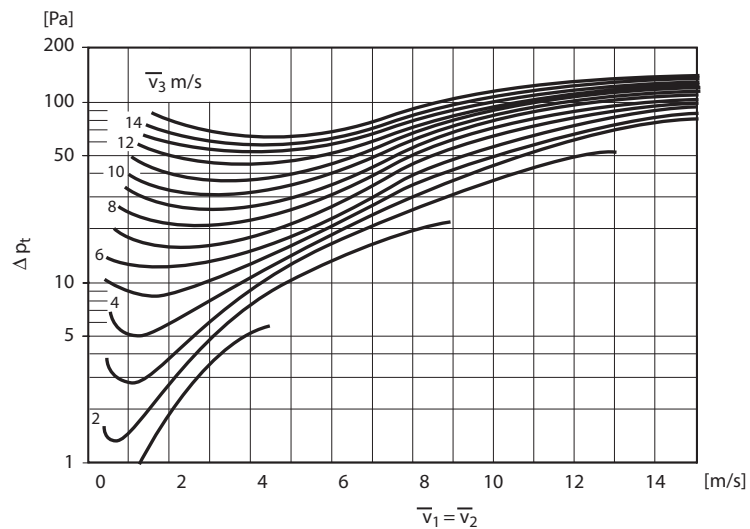
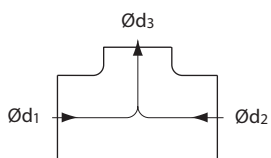

- 1
- 2
- 3
- 4
- 5
- 6
- 7
- 8
- 9
- 10
- 11
- 12
- 13
- 14
- 15
- 16
- 17
- 18