

230VAc  
Fuse 6,3A

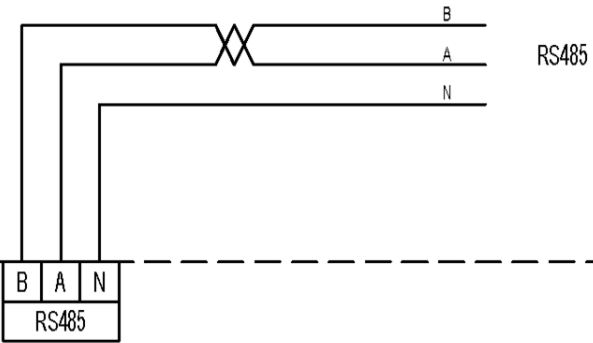

FDS-M MASTER UNIT

B A N  
RS485

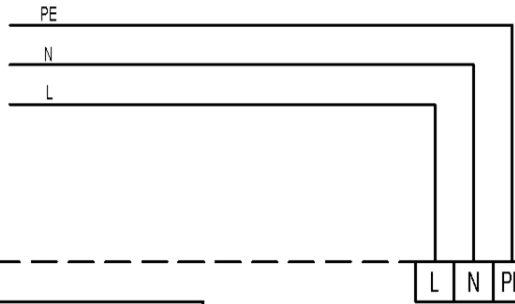
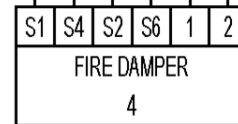
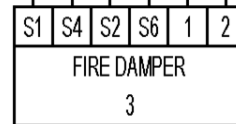
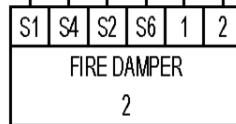
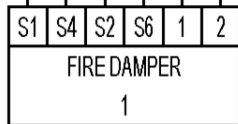
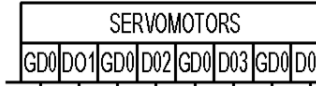
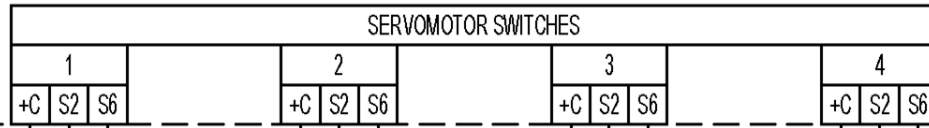

MANUFACTURER: Manufacturer 1	PROJECT DESCRIPTION: FDS-M	PROJECT NUMBER: Project Number
Manufacturer 2	DAMPERS	ELECTRICAL PANELS N: Electrical Panel
Manufacturer 3	COMMUNICATION	



PAGE DESCRIPTION: Page Description	REVISION BY:	PAGE CREATE DATE:	PAGE:
DRAWN BY:	CHECK BY: Check by	PAGE REVISION DATE:	PAGES:

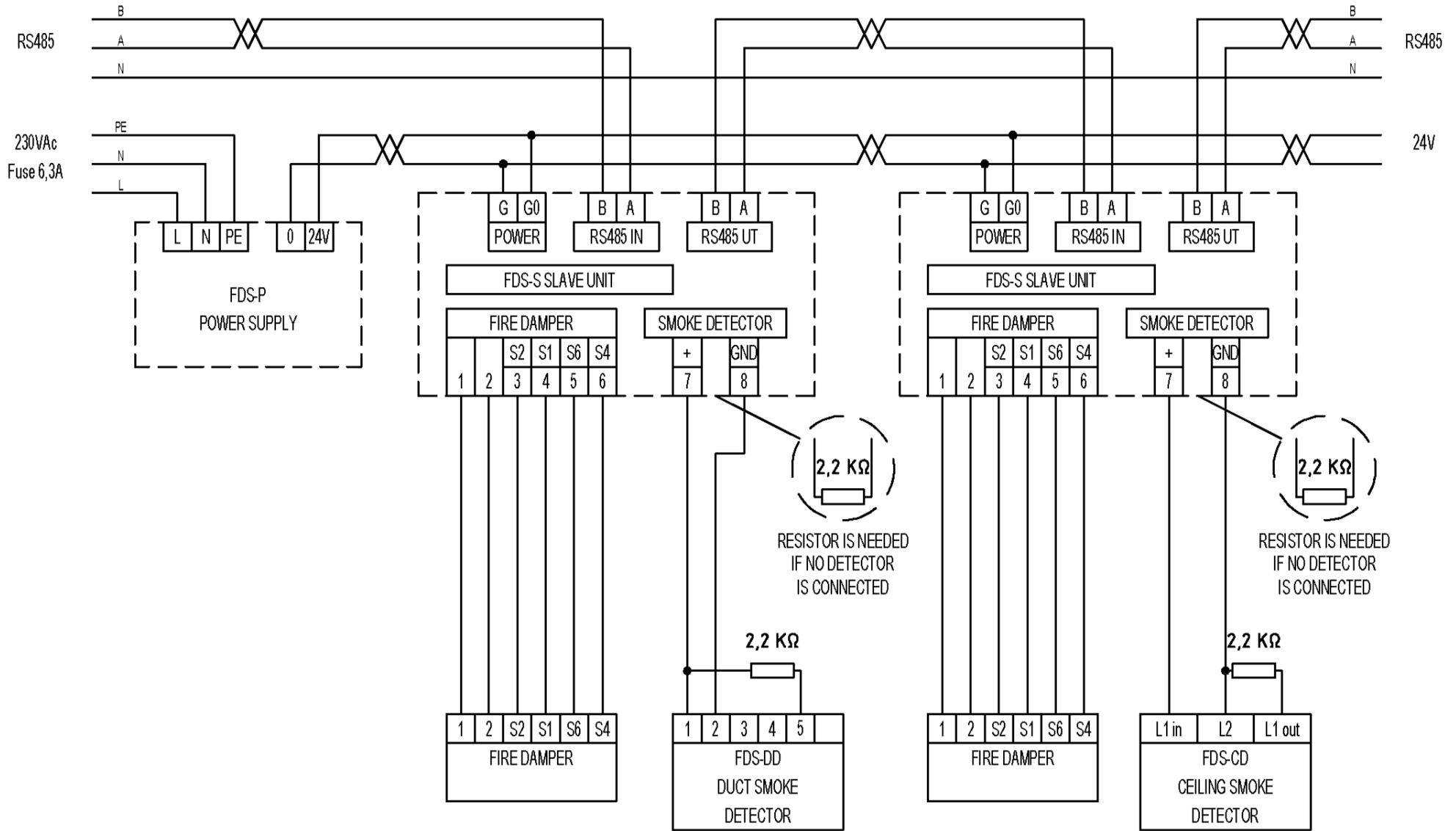

MANUFACTURER:

Manufacturer 1

Manufacturer 2

Manufacturer 3

PROJECT DESCRIPTION:

FDS-S

DAMPERS

CD, DD

PROJECT NUMBER

Project Number

ELECTRICAL PANELS.N:

Electrical Panel



PAGE DESCRIPTION:

Page Description

DRAWN BY:

REVISION BY:

CHECK BY:

Check by

PAGE CREATE DATE:

PAGE REVISION DATE:

PAGES:

PAGE:

PAGES:

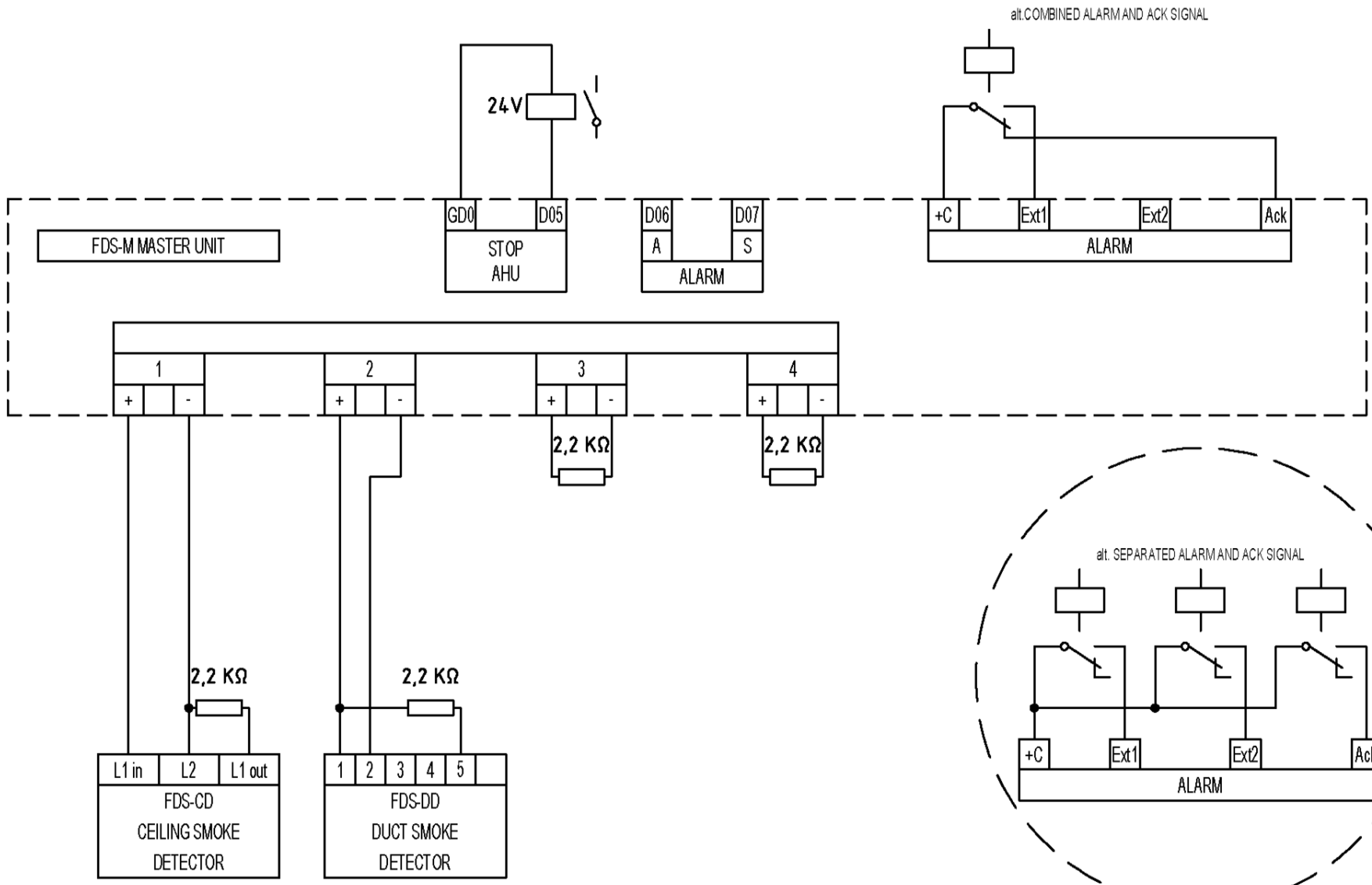

MANUFACTURER: Manufacturer 1	PROJECT DESCRIPTION: FDS-M AHU, EXT, CD, DD	PROJECT NUMBER: Project Number
Manufacturer 2		ELECTRICAL PANELS.N: Electrical Panel
Manufacturer 3		



PAGE DESCRIPTION: Page Description	REVISION BY:	PAGE CREATE DATE:	PAGE:
DRAWN BY:	CHECK BY: Check by	PAGE REVISION DATE:	PAGES: