

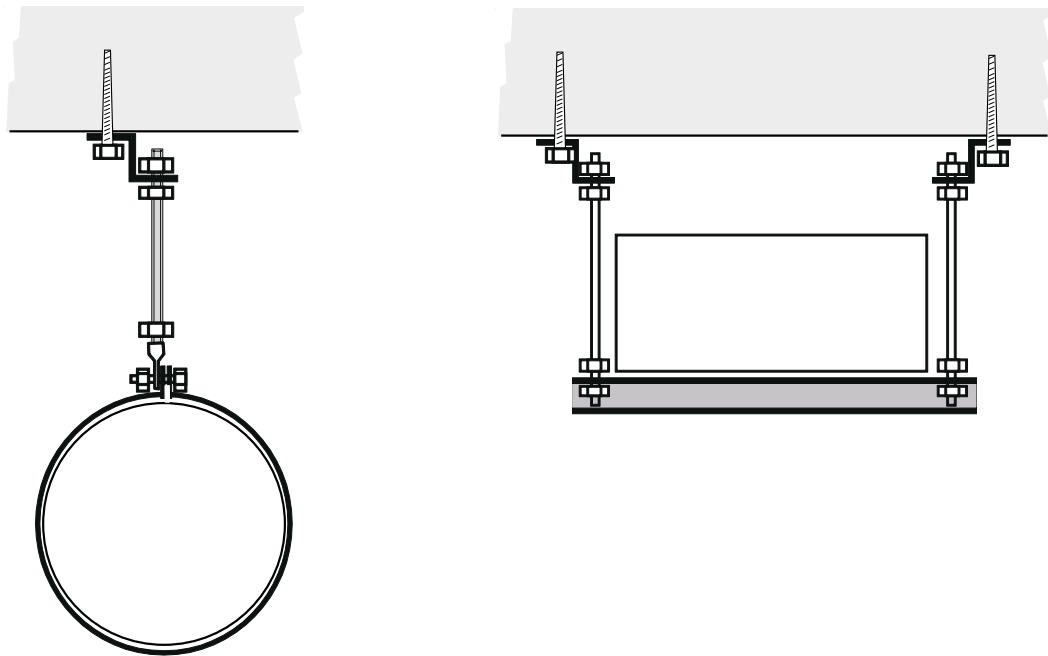

Suspension of ventilation systems

Lindab's recommendations



Content

General page

Examples of suspension	3
Lower requirements of bearing capacity	
Suspension <u>without</u> requirements of fire class	4
Suspension <u>with</u> requirements of fire class	

Suspension of circular duct

No fire class	Suspension band 25x1,25		5
	Threaded rod M8		
	Suspension band 25x0,90		6
	Suspension band 20x0,70		
Fire class	R 15	Suspension band 25x1,25 Threaded rod M8	Wire net mat 8
	R 30	Suspension band 30x1,00 Threaded rod M8	Wire net mat 10
	R60	Threaded rod M10	Wire net mat 12

Suspension of rectangular duct

No fire class	Suspension band 25x1,25		14	
	Mounting bracket for ventilation duct			
	Threaded rod M8			
	Suspension band 25x0,90		15	
	Suspension band 20x0,70			
	R 15	Suspension band 25x1,25		Wire net mat
Threaded rod M8				
Fire class	R 15	Suspension band 25x1,25	Board	21
		Threaded rod M8		
	R 30	Suspension band 30x1,00	Wire net mat	24
		Threaded rod M8		
		Suspension band 30x1,00	Board	27
	R60	Threaded rod M8		
Threaded rod M10		Wire net mat	30	
	Threaded rod M10	Board	33	

General

The suspension solutions shown in this pamphlet are based on Swedish practice. This practice is well-trying and developed during many years.

The complete suspension is called the "suspension device". This consists of "brackets" and "fasteners".

Suspension device Usually divided into:	
Brackets	Fasteners
Devices for joining, linking between, bridging or linking to.	Devices for joining, locking or fixing in place with.
Example: Ceiling bracket, profile, rail, bracket, threaded rod, mounting tape, wire, chain, suspension ring, cradle, bracket – including all accessories.	Example: Screw, plug, bolt, nut, washer, rivet, nail.

N.B. The suspension device should also include

devices that hold the ventilation system from the side or support it from below, e.g. Lindab's FA, "Bigfoot" and gantry systems such as the "channel framing system" and "Tecstrut".

Examples of suspension

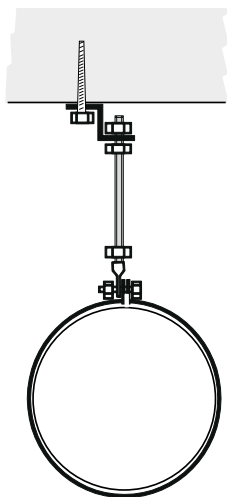

Circular ducts single suspended using anchor bolt, Z bracket, threaded rod, blade sleeve and suspension ring.

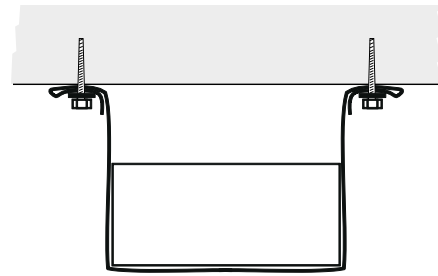

Rectangular duct double-suspended with anchor bolts, Suspension bands and self-tapping screws.

The function of the suspension apparatus is to keep the ventilation system in place. This function can be divided into various requirements. It may be dimensioned for the weight of the duct system. It can also be dimensioned to cope with a possible fire and the requirements stipulated according to the building's classification.

Buildings are classified in accordance with the Swedish National Board of Housing, Building and Planning building regulations (BBR 5:21) in three classes (Br1, Br2 and Br3).

With regard to fire resistance rating of the bearing capacity, this is shown using the letter R followed by a time requirement (15, 30, etc.).

A suitable dimensioning of the bearing capacity R is equivalent to the fire resistance of a construction with a through hole e.g. if the construction is rated EI 60, the suspension apparatus should be chosen with a bearing capacity of R 60.

Lower requirements of bearing capacity

In some cases, the bearing capacity of the suspension device can be reduced. This applies to places where a potentially fallen duct does not interfere with the open-work construction's overall fire resistance and/or does not reduce protection the spread of combustion gases via the ventilation system.

The bearing capacity can then be reduced for example, according to:

- R 15 – within isolated fire resistant evacuation routes, fan rooms, shafts, or linings. This is due to the low fire load there.
- R 15 – in sprinkler areas.

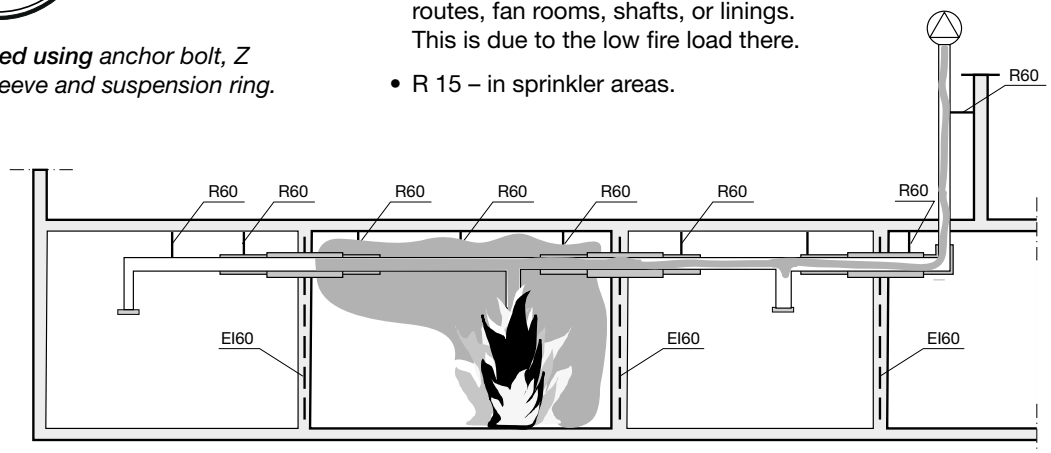

Suspension without requirements of fire class

The fire requirement for a suspension with regard to emergency services' safety is for all suspensions to cope with at least 300 °C for 10 minutes without falling down.

The force in the suspension is caused by the total weight of the duct and a point load (102 kg) plus any insulation and components (e.g. silencers). The suspension distance is selected so that the force does not exceed what the weakest link in the suspension can handle.

The maximum suspension distance for horizontal circular ducts is 3 m and 2,4 m for horizontal rectangular ducts. The reason is that it is inappropriate to have more than one duct joint between the suspension points.

For vertical ducts, the maximum distance is 3 m for both circular and rectangular ducts.

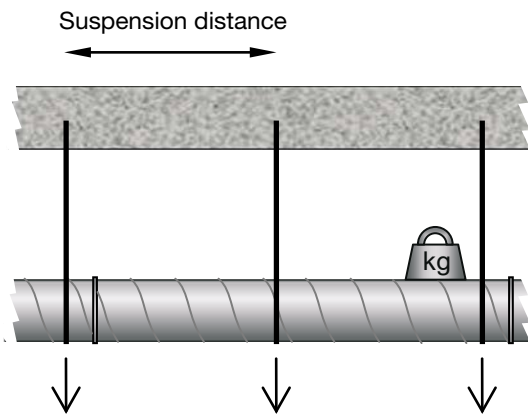

Suspension distance:

Example calculation with *single* suspension.

Permitted force in the suspension 1 700 N

	Weight	Force
Duct	12 kg/m	118 N/m
Point load	102 kg	1000 N
Total		1118 N/m

Distance, theoretical: $1700 / 1118 = 1,5$ m

Suspension with requirements of fire class

The fire requirement for a suspension is that all the links in the suspension must meet the required fire class.

The force in the suspension is caused by the total weight of the duct plus any insulation and components (e.g. silencers). The suspension distance is selected so that the force does not exceed what is permitted for the weakest link in the suspension.

The maximum suspension distance for horizontal circular ducts is 3 m and 2,4 m for horizontal rectangular ducts. The reason is that it is inappropriate to have more than one duct joint between the suspension points.

For vertical ducts, the maximum distance is 3 m for both circular and rectangular ducts.

Suspension rings and similar should be placed inside the insulation.

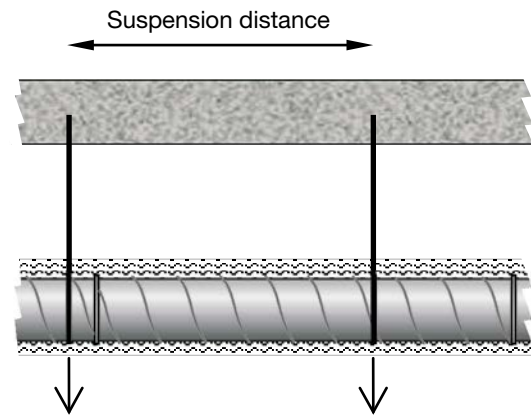

Suspension distance:

Example calculation with *single* suspension.

Permitted force in the suspension 500 N

	Weight	Force
Duct	12 kg/m	118 N/m
Insulation	6,5 kg/m	64 N/m
Total		182 N/m

Distance $500 / 182 = 2,8$ m

Circular duct

Uninsulated

Recommended suspension

No fire class

	Product	Number	Specification	Material
Fastening to ceiling	Approved fastener	1		
	Suspension band folded			
	Rectangular washer	1	25 × 25 × 3	Steel
Pendulum between ceiling and duct	Suspension band	1	25 × 1,25 Ø 10,0 / 8,5 / 3,3	SIS 1311
Fastening to duct bearing section	Hexagonal screw with flange	1	M8 × 30	Steel
	Hexagonal nut with flange	1	M8	Steel
	Suspension band in circumferential loop, folded			

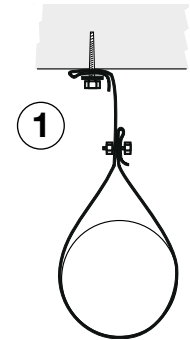

	Product	Number	Specification	Material
Fastening to ceiling	Approved fastener	2		
	Suspension band folded			
	Rectangular washer	2	25 × 25 × 3	Steel
Pendulum between ceiling and duct	Suspension band	1 (2)	25 × 1,25 Ø 10,0 / 8,5 / 3,3	SIS 1311
Fastening to duct bearing section	Suspension band circumferential			

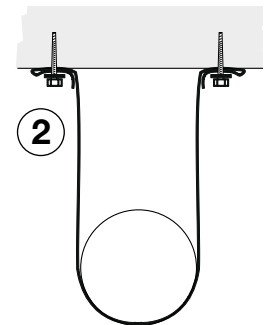

	Product	Number	Specification	Material
Fastening to ceiling	Approved fastener	1		
	Hexagonal nut with flange	1	M8	Steel
	Z bracket	1	25 × 4	Steel
	Hexagonal nut with flange	1	M8	Steel
Pendulum between ceiling and duct	Threaded rod	1	M8	Bright/electro-zinc-plated qual. 4,6
Fastening to duct bearing section	Hexagonal nut with flange	1	M8	Steel
	Blade sleeve	1	M8	Steel
	Hexagonal screw with flange	1	M8 × 30	Steel
	Hexagonal nut with flange	1	M8	Steel
	Complete suspension ring, UV	1		SIS 1312/FFZV

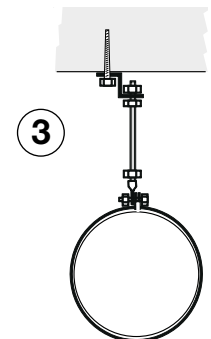

	Product	Number	Specification	Material
Fastening to ceiling	Approved fastener	2		
	Hexagonal nut with flange	2	M8	Steel
	Z bracket	2	25 × 4	Steel
	Hexagonal nut with flange	2	M8	Steel
Pendulum between ceiling and duct	Threaded rod	2	M8	Bright/electro-zinc-plated qual. 4,6
Fastening to duct bearing section	Hexagonal nut with flange	2	M8	Steel
	Half suspension ring, UVH	2		SIS 1312/FFZV
	Hexagonal nut with flange	2	M8	Steel

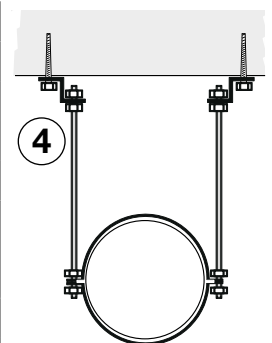

Circular duct

Uninsulated

Recommended suspension

No fire class

	Product	Number	Specification	Material
Fastening to ceiling	Approved fastener	1		
	Suspension band folded Rectangular washer	1	25 × 25 × 3	Steel
Pendulum between ceiling and duct	Suspension band	1	25 × 0,90 Ø 8,5 / 6,5 / 3,3	FFZV, Z275
Fastening to duct bearing section	Hexagonal screw with flange	1	M8 × 30	Steel
	Hexagonal nut with flange Suspension band in circumferential loop, folded	1	M8	Steel

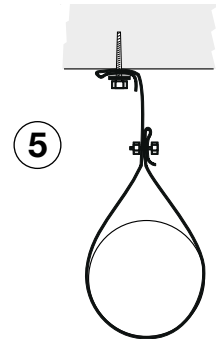

	Product	Number	Specification	Material
Fastening to ceiling	Approved fastener	2		
	Suspension band folded Rectangular washer	2	25 × 25 × 3	Steel
Pendulum between ceiling and duct	Suspension band	1 (2)	25 × 0,90 Ø 8,5 / 6,5 / 3,3	FFZV, Z275
Fastening to duct bearing section	Suspension band circumferential			

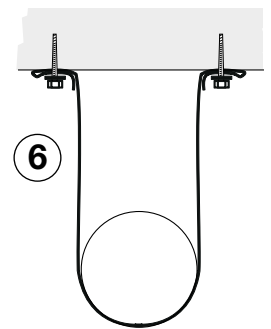

	Product	Number	Specification	Material
Fastening to ceiling	Approved fastener	2		
	Suspension band folded Rectangular washer	2	25 × 25 × 3	Steel
Pendulum between ceiling and duct	Suspension band	1 (2)	20 × 0,70 Ø 7,0 / 5,0 / 3,1	FFZV, Z275
Fastening to duct bearing section	Suspension band circumferential			

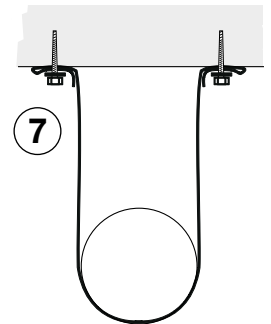

Circular duct

Uninsulated

Recommended suspension distance

No fire class

Insulation	product material	None	
	density	0	[kg/m ³]
	thickness	0	[mm]
	Longest suspension distance	3,0	[m]

Duct		Pendulum [type]						
		Suspension band		Threaded rod		Suspension band		Suspension band
		Number of pendulums						
Ø	Specific weight	1	2	1	2	1	2	2
[mm]	[kg/m]	[m]	[m]	[m]	[m]	[m]	[m]	[m]
		Max. permitted load for each pendulum [N]						
		1700	1700	5000	5000	1200	1200	800
		Point load [N]						
		1000	1000	1000	1000	1000	1000	1000
		Recommended suspension distance						
		3,0	3,0	3,0	3,0	3,0	3,0	3,0
63	0,89	3,0	3,0	3,0	3,0	3,0	3,0	3,0
80	0,91	3,0	3,0	3,0	3,0	3,0	3,0	3,0
100	1,14	3,0	3,0	3,0	3,0	3,0	3,0	3,0
112	1,42	3,0	3,0	3,0	3,0	3,0	3,0	3,0
125	1,41	3,0	3,0	3,0	3,0	3,0	3,0	3,0
140	1,76	3,0	3,0	3,0	3,0	3,0	3,0	3,0
150	1,89	3,0	3,0	3,0	3,0	3,0	3,0	3,0
160	2,02	3,0	3,0	3,0	3,0	3,0	3,0	3,0
180	2,26	3,0	3,0	3,0	3,0	3,0	3,0	3,0
200	2,56	3,0	3,0	3,0	3,0	3,0	3,0	3,0
224	3,42	3,0	3,0	3,0	3,0	3,0	3,0	3,0
250	3,18	3,0	3,0	3,0	3,0	3,0	3,0	3,0
280	3,92	3,0	3,0	3,0	3,0	3,0	3,0	3,0
300	4,20	3,0	3,0	3,0	3,0	3,0	3,0	3,0
315	4,41	3,0	3,0	3,0	3,0	3,0	3,0	3,0
355	4,96	3,0	3,0	3,0	3,0	3,0	3,0	3,0
400	6,01	3,0	3,0	3,0	3,0	3,0	3,0	3,0
450	8,60	3,0	3,0	3,0	3,0	2,4	3,0	3,0
500	9,54	3,0	3,0	3,0	3,0	2,1	3,0	3,0
560	12,2	3,0	3,0	3,0	3,0	1,7	3,0	3,0
600	13,1	3,0	3,0	3,0	3,0	1,6	3,0	3,0
630	12,0	3,0	3,0	3,0	3,0	1,7	3,0	3,0
710	15,5	3,0	3,0	3,0	3,0	1,3	3,0	3,0
800	17,4	3,0	3,0	3,0	3,0	1,2	3,0	3,0
900	21,7	3,0	3,0	3,0	3,0	0,9	3,0	2,8
1000	24,1	3,0	3,0	3,0	3,0	0,8	3,0	2,5
1120	27,0	2,6	3,0	3,0	3,0	0,8	3,0	2,3
1250	30,2	2,4	3,0	3,0	3,0	0,7	3,0	2,0
1400	48,0	1,5	3,0	3,0	3,0	0,4	3,0	1,3
1500	51,4	1,4	3,0	3,0	3,0	0,4	2,8	1,2
1600	54,8	1,3	3,0	3,0	3,0	0,4	2,6	1,1

Circular duct

Insulated EI 15

Recommended suspension

Fire class R 15

	Product	Number	Specification	Material
Fastening to ceiling	Approved fastener	1		
	Suspension band folded			
	Rectangular washer	1	25 × 25 × 3	Steel
Pendulum between ceiling and duct	Suspension band	1	25 × 1,25 Ø 10,0 / 8,5 / 3,3	SIS 1311
Fastening to duct bearing section	Hexagonal screw with flange	1	M8 × 30	Steel
	Hexagonal nut with flange	1	M8	Steel
	Suspension band in circumferential loop, folded			
Fire insulation	Wire net mat		30 mm	100 kg/m ³

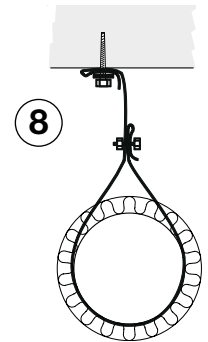

	Product	Number	Specification	Material
Fastening to ceiling	Approved fastener	2		
	Suspension band folded			
	Rectangular washer	2	25 × 25 × 3	Steel
Pendulum between ceiling and duct	Suspension band	1 (2)	25 × 1,25 Ø 10,0 / 8,5 / 3,3	SIS 1311
Fastening to duct bearing section	Suspension band circumferential			
Fire insulation	Wire net mat		30 mm	100 kg/m ³

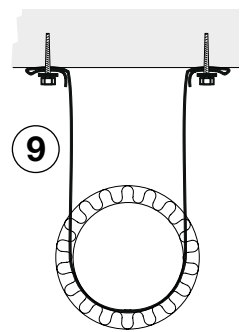

	Product	Number	Specification	Material
Fastening to ceiling	Approved fastener	1		
	Hexagonal nut with flange	1	M8	Steel
	Z bracket	1	25 × 4	Steel
	Hexagonal nut with flange	1	M8	Steel
	Pendulum between ceiling and duct	Threaded rod	1	M8
Fastening to duct bearing section	Hexagonal nut with flange	1	M8	Steel
	Blade sleeve	1	M8	Steel
	Hexagonal screw with flange	1	M8 × 30	Steel
	Hexagonal nut with flange	1	M8	Steel
	Complete suspension ring, UV	1	*	SIS 1312 / FFZV
Fire insulation	Wire net mat		30 mm	100 kg/m ³

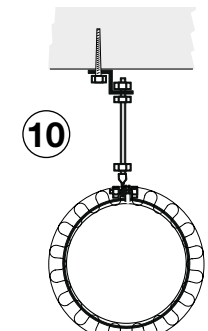

*
 -125 1,25 × 30
 160-315 1,5 × 30
 400-630 2,0 × 30
 800- 3,0 × 30

	Product	Number	Specification	Material
Fastening to ceiling	Approved fastener	2		
	Hexagonal nut with flange	2	M8	Steel
	Z bracket	2	25 × 4	Steel
	Hexagonal nut with flange	2	M8	Steel
	Pendulum between ceiling and duct	Threaded rod	2	M8
Fastening to duct bearing section	Hexagonal screw with flange	2	M8	Steel
	Half suspension ring, UVH	2	*	SIS 1312 / FFZV
	Hexagonal nut with flange	2	M8	Steel
Fire insulation	Wire net mat		30 mm	100 kg/m ³

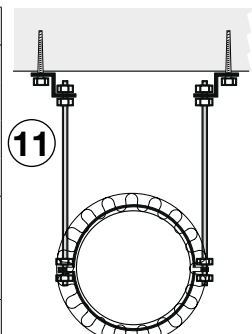

*
 -125 1,25 × 30
 160-315 1,5 × 30
 400-630 2,0 × 30
 800- 3,0 × 30

Circular duct

Insulated EI 15

Recommended suspension distance

Fire class R 15

Insulation	product	Wire net mat	
	material	Rock wool	
	density	100	[kg/m ³]
	thickness	30	[mm]
Longest suspension distance		3,0	[m]

Duct		Pendulum [type]			
		Suspension band		Threaded rod	
		Number of pendulums			
		1	2	1	2
		Max. permitted load for each pendulum [N]			
		500	500	1000	1000
		Recommended suspension distance			
Ø	Specific weight	[m]	[m]	[m]	[m]
[mm]	[kg/m]	[m]	[m]	[m]	[m]
63	2,05	3,0	3,0	3,0	3,0
80	2,23	3,0	3,0	3,0	3,0
100	2,65	3,0	3,0	3,0	3,0
112	3,04	3,0	3,0	3,0	3,0
125	3,15	3,0	3,0	3,0	3,0
140	3,64	3,0	3,0	3,0	3,0
150	3,87	3,0	3,0	3,0	3,0
160	4,09	3,0	3,0	3,0	3,0
180	4,52	3,0	3,0	3,0	3,0
200	5,01	3,0	3,0	3,0	3,0
224	6,10	3,0	3,0	3,0	3,0
250	6,10	3,0	3,0	3,0	3,0
280	7,12	3,0	3,0	3,0	3,0
300	7,59	3,0	3,0	3,0	3,0
315	7,94	3,0	3,0	3,0	3,0
355	8,87	3,0	3,0	3,0	3,0
400	10,3	3,0	3,0	3,0	3,0
450	13,4	3,0	3,0	3,0	3,0
500	14,8	3,0	3,0	3,0	3,0
560	18,0	2,8	3,0	3,0	3,0
600	19,3	2,6	3,0	3,0	3,0
630	18,5	2,8	3,0	3,0	3,0
710	22,8	2,2	3,0	3,0	3,0
800	25,5	2,0	3,0	3,0	3,0
900	30,7	1,7	3,0	3,0	3,0
1000	34,1	1,5	3,0	3,0	3,0
1120	38,1	1,3	2,7	2,7	3,0
1250	42,5	1,2	2,4	2,4	3,0
1400	61,8	0,8	1,7	1,7	3,0
1500	66,1	0,8	1,5	1,5	3,0
1600	70,4	0,7	1,4	1,4	2,9

Circular duct

Insulated EI 30

Recommended suspension

Fire class R 30

	Product	Number	Specification	Material
Fastening to ceiling	Approved fastener	1		
	Suspension band folded			
	Rectangular washer	1	25 × 25 × 3	Steel
Pendulum between ceiling and duct	Suspension band	1	30 × 1,0 Ø 10,5 / 8,5	SIS 2333
Fastening to duct bearing section	Hexagonal screw with flange	1	M8 × 30	Steel
	Hexagonal nut with flange	1	M8	Steel
	Suspension band in circumferential loop, folded			
Fire insulation	Wire net mat		50 mm	100 kg/m ³

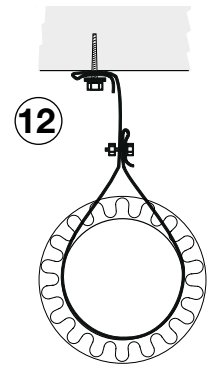

	Product	Number	Specification	Material
Fastening to ceiling	Approved fastener	2		
	Suspension band folded			
	Rectangular washer	2	25 × 25 × 3	Steel
Pendulum between ceiling and duct	Suspension band	1 (2)	30 × 1,0 Ø 10,5 / 8,5	SIS 2333
Fastening to duct bearing section	Suspension band circumferential			
Fire insulation	Wire net mat		50 mm	100 kg/m ³

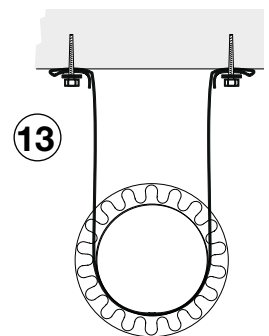

	Product	Number	Specification	Material
Fastening to ceiling	Approved fastener	1		
	Hexagonal nut with flange	1	M8	Steel
	Z bracket	1	25 × 4	Steel
	Hexagonal nut with flange	1	M8	Steel
Pendulum between ceiling and duct	Threaded rod	1	M8	Bright/electro-zinc-plated qual. 4,6
Fastening to duct bearing section	Hexagonal nut with flange	1	M8	Steel
	Blade sleeve	1	M8	Steel
	Hexagonal screw with flange	1	M8 × 30	Steel
	Hexagonal nut with flange	1	M8	Steel
	Complete suspension ring, UV	1	*	SIS 1312 / FFZV
Fire insulation	Wire net mat		50 mm	100 kg/m ³

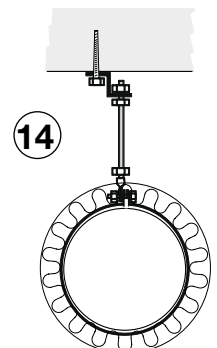

*
 -125 1,25 × 30
 160-315 1,5 × 30
 400-630 2,0 × 30
 800- 3,0 × 30

	Product	Number	Specification	Material
Fastening to ceiling	Approved fastener	2		
	Hexagonal nut with flange	2	M8	Steel
	Z bracket	2	25 × 4	Steel
	Hexagonal nut with flange	2	M8	Steel
Pendulum between ceiling and duct	Threaded rod	2	M8	Bright/electro-zinc-plated qual. 4,6
Fastening to duct bearing section	Hexagonal nut with flange	2	M8	Steel
	Half suspension ring, UVH	2	*	SIS 1312 / FFZV
	Hexagonal nut with flange	2	M8	Steel
Fire insulation	Wire net mat		50 mm	100 kg/m ³

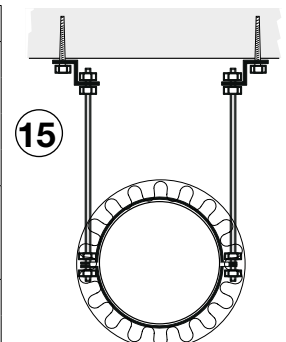

*
 -125 1,25 × 30
 160-315 1,5 × 30
 400-630 2,0 × 30
 800- 3,0 × 30

Circular duct

Insulated EI 30

Recommended suspension distance

Fire class R 30

Insulation	product	Wire net mat	
	material	Rock wool	
	density	100	[kg/m ³]
	thickness	50	[mm]
Longest suspension distance		3,0	[m]

Duct		Pendulum [type]					
		12		13		14	
		Suspension band		Threaded rod			
		Number of pendulums					
		1	2	1	2	1	2
		Max. permitted load for each pendulum [N]					
		1000	1000	1000	1000	1000	1000
		Recommended suspension distance					
Ø	Specific weight	[m]	[m]	[m]	[m]	[m]	[m]
[mm]	[kg/m]	[m]	[m]	[m]	[m]	[m]	[m]
63	3,45	3,0	3,0	3,0	3,0	3,0	3,0
80	3,74	3,0	3,0	3,0	3,0	3,0	3,0
100	4,28	3,0	3,0	3,0	3,0	3,0	3,0
112	4,75	3,0	3,0	3,0	3,0	3,0	3,0
125	4,94	3,0	3,0	3,0	3,0	3,0	3,0
140	5,53	3,0	3,0	3,0	3,0	3,0	3,0
150	5,82	3,0	3,0	3,0	3,0	3,0	3,0
160	6,10	3,0	3,0	3,0	3,0	3,0	3,0
180	6,66	3,0	3,0	3,0	3,0	3,0	3,0
200	7,27	3,0	3,0	3,0	3,0	3,0	3,0
224	8,51	3,0	3,0	3,0	3,0	3,0	3,0
250	8,68	3,0	3,0	3,0	3,0	3,0	3,0
280	9,89	3,0	3,0	3,0	3,0	3,0	3,0
300	10,5	3,0	3,0	3,0	3,0	3,0	3,0
315	10,9	3,0	3,0	3,0	3,0	3,0	3,0
355	12,1	3,0	3,0	3,0	3,0	3,0	3,0
400	13,9	3,0	3,0	3,0	3,0	3,0	3,0
450	17,2	3,0	3,0	3,0	3,0	3,0	3,0
500	19,0	3,0	3,0	3,0	3,0	3,0	3,0
560	22,6	3,0	3,0	3,0	3,0	3,0	3,0
600	24,1	3,0	3,0	3,0	3,0	3,0	3,0
630	23,5	3,0	3,0	3,0	3,0	3,0	3,0
710	28,2	3,0	3,0	3,0	3,0	3,0	3,0
800	31,5	3,0	3,0	3,0	3,0	3,0	3,0
900	37,4	2,7	3,0	2,7	3,0	2,7	3,0
1000	41,4	2,5	3,0	2,5	3,0	2,5	3,0
1120	46,2	2,2	3,0	2,2	3,0	2,2	3,0
1250	51,4	2,0	3,0	2,0	3,0	2,0	3,0
1400	71,6	1,4	2,8	1,4	2,8	1,4	2,8
1500	76,5	1,3	2,7	1,3	2,7	1,3	2,7
1600	81,5	1,3	2,5	1,3	2,5	1,3	2,5

Circular duct

Insulated EI 60

Recommended suspension

Fire class R 60

	Product	Number	Specification	Material
Fastening to ceiling	Approved fastener	1		
	Hexagonal nut with flange	1	M10	Steel
	Z bracket	1	25 × 4	Steel
	Hexagonal nut with flange	1	M10	Steel
Pendulum between ceiling and duct	Threaded rod	1	M10	Bright/electro-zinc-plated qual. 4,6
Fastening to duct bearing section	Hexagonal nut with flange	1	M10	Steel
	Blade sleeve	1	M10	Steel
	Hexagonal screw with flange	1	M10 × 30	Steel
	Hexagonal nut with flange	1	M10	Steel
	Complete suspension ring, UV	1	*	SIS 1312 / FFZV
Fire insulation	Wire net mat		100 mm	100 kg/m ³

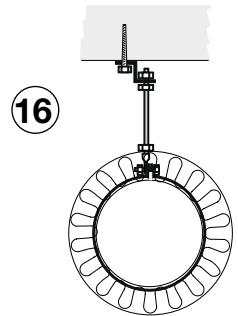

- * -125 1,25 × 30
 160-315 1,5 × 30
 400-630 2,0 × 30
 800- 3,0 × 30

	Product	Number	Specification	Material
Fastening to ceiling	Approved fastener	2		
	Hexagonal nut with flange	2	M10	Steel
	Z bracket	2	25 × 4	Steel
	Hexagonal nut with flange	2	M1	Steel
Pendulum between ceiling and duct	Threaded rod	2	M10	Bright/electro-zinc-plated qual. 4,6
Fastening to duct bearing section	Hexagonal nut with flange	2	M10	Steel
	Half suspension ring, UVH	2	*	SIS 1312 / FFZV
	Hexagonal nut with flange	2	M10	Steel
Fire insulation	Wire net mat		100 mm	100 kg/m ³

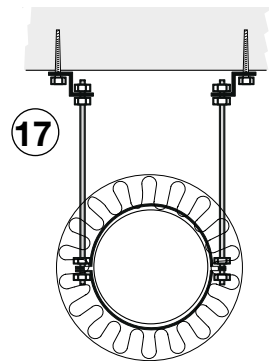

- * -125 1,25 × 30
 160-315 1,5 × 30
 400-630 2,0 × 30
 800- 3,0 × 30

Circular duct

Recommended suspension distance

Insulated EI 60

Fire class R 60

Insulation	product	Wire net mat	
	material	Rock wool	
	density	100	[kg/m ³]
	thickness	100	[mm]
Longest suspension distance		3,0	[m]

Duct		16		17	
		Pendulum [type]			
		Threaded rod			
		Number of pendulums			
		1	2		
Ø	Specific weight	Max. permitted load for each pendulum [N]			
		1000	1000		
		Recommended suspension distance			
[mm]	[kg/m]	[m]	[m]		
63	9,15	3,0	3,0		
80	9,71	3,0	3,0		
100	10,6	3,0	3,0		
112	11,2	3,0	3,0		
125	11,6	3,0	3,0		
140	12,4	3,0	3,0		
150	12,9	3,0	3,0		
160	13,3	3,0	3,0		
180	14,2	3,0	3,0		
200	15,1	3,0	3,0		
224	16,7	3,0	3,0		
250	17,3	3,0	3,0		
280	19,0	3,0	3,0		
300	19,9	3,0	3,0		
315	20,6	3,0	3,0		
355	22,4	3,0	3,0		
400	24,9	3,0	3,0		
450	29,0	3,0	3,0		
500	31,5	3,0	3,0		
560	36,1	2,8	3,0		
600	38,2	2,7	3,0		
630	38,1	2,7	3,0		
710	44,1	2,3	3,0		
800	48,8	2,1	3,0		
900	56,3	1,8	3,0		
1000	61,8	1,6	3,0		
1120	68,5	1,5	3,0		
1250	75,8	1,3	2,7		
1400	98,3	1,0	2,1		
1500	105	1,0	1,9		
1600	111	0,9	1,8		

Rectangular duct

Uninsulated

Recommended suspension

No fire class

	Product	Number	Specification	Material
Fastening to ceiling	Approved fastener	2		
	Suspension band folded			
	Rectangular washer	2	25 × 25 × 3	Steel
Pendulum between ceiling and duct	Suspension band	1 (2)	25 × 1,25 Ø 10,0 / 8,5 / 3,3	SIS 1311
Fastening to duct bearing section	Suspension band circumferential			

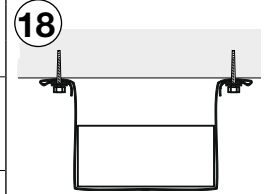

	Product	Number	Specification	Material
Fastening to ceiling	Approved fastener	2		
	Suspension band folded			
	Rectangular washer	2	25 × 25 × 3	Steel
Pendulum between ceiling and duct	Suspension band	2	25 × 1,25 Ø 10,0 / 8,5 / 3,3	SIS 1311
Fastening to duct bearing section	Self-tapping screws or blind rivet	4	4,2 × 13	Steel
		4	4,0 × 9	Steel
	Suspension band screwed/riveted			

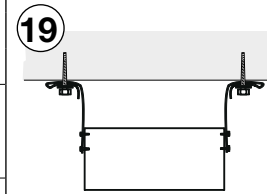

	Product	Number	Specification	Material
Fastening to ceiling	Approved fastener	2		
	Mounting bracket for ventilation duct	2		Steel
Pendulum between ceiling and duct	Mounting bracket for ventilation duct	2		
Fastening to duct bearing section	Self-tapping screws or blind rivet	4	4,2 × 13	Steel
		4	4,0 × 9	Steel
	Mounting bracket screwed/riveted			

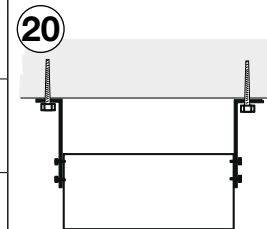

	Product	Number	Specification	Material
Fastening to ceiling	Approved fastener	2		
	Hexagonal nut with flange	2	M8	Steel
	Z bracket	2	25 × 4	Steel
	Hexagonal nut with flange	2	M8	Steel
Pendulum between ceiling and duct	Threaded rod	2	M8	Bright/ electro-zinc-plated qual. 4,6
Fastening to duct bearing section	Hexagonal nut with flange	2	M8	Steel
	Channel (ceiling bracket)	1	Height depending on load × min. 3	Steel
	or Rail / Channel	1	Height depending on load × 2-3	Steel
	Hexagonal nut with flange	2	M8	Steel

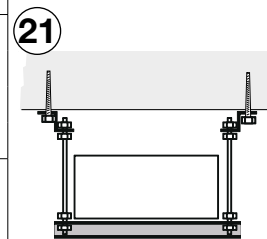

Rectangular duct

Uninsulated

Recommended suspension

No fire class

	Product	Number	Specification	Material
Fastening to ceiling	Approved fastener	2		
	Suspension band folded			
	Rectangular washer	2	25 × 25 × 3	Steel
Pendulum between ceiling and duct	Suspension band	1 (2)	25 × 0,90 Ø 8,5 / 6,5 / 3,3	FFZV, Z 275
Fastening to duct bearing section	Suspension band circumferential			

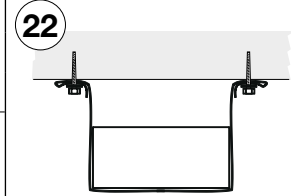

	Product	Number	Specification	Material
Fastening to ceiling	Approved fastener	2		
	Suspension band folded			
	Rectangular washer	2	25 × 25 × 3	Steel
Pendulum between ceiling and duct	Suspension band	2	25 × 0,90 Ø 8,5 / 6,5 / 3,3	FFZV, Z 275
Fastening to duct bearing section	Self-tapping screws or blind rivet	4	4,2 × 13	Steel
		4	4,0 × 9	Steel
	Suspension band screwed/riveted			

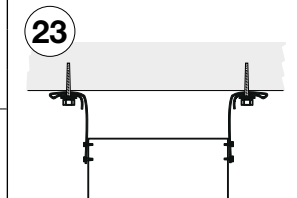

	Product	Number	Specification	Material
Fastening to ceiling	Approved fastener	2		
	Suspension band folded			
	Rectangular washer	2	25 × 25 × 3	Steel
Pendulum between ceiling and duct	Suspension band	1 (2)	20 × 0,70 Ø 7,0 / 5,0 / 3,1	FFZV, Z 275
Fastening to duct bearing section	Suspension band circumferential			

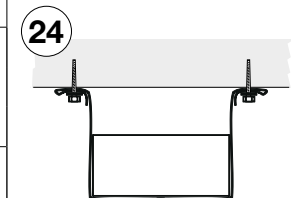

	Product	Number	Specification	Material
Fastening to ceiling	Approved fastener	2		
	Suspension band folded			
	Rectangular washer	2	25 × 25 × 3	Steel
Pendulum between ceiling and duct	Suspension band	2	20 × 0,70 Ø 7,0 / 5,0 / 3,1	FFZV, Z 275
Fastening to duct bearing section	Self-tapping screws or blind rivet	4	4,2 × 13	Steel
		4	4,0 × 9	Steel
	Suspension band screwed/riveted			

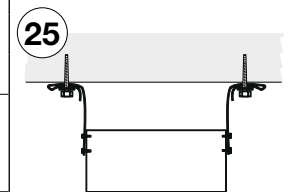

Rectangular duct

Uninsulated

Recommended suspension distance

No fire class

Insulation	product	None
	material	None
	density	0 [kg/m ³]
	thickness	0 [mm]
Longest suspension distance		2,4 [m]

		18	19	20	21	22	23	24	25
		Pendulum [type]							
		Suspension band or mounting bracket	Threaded rod		Suspension band				
		Number of pendulums							
		2	2		2		2		
		Max. permitted load for each pendulum [N]							
		1700	5000		1200		800		
		Point load [N]							
		1000	1000		1000		1000		
		Recommended suspension distance							
		[m]	[m]	[m]	[m]	[m]	[m]	[m]	
200	100	0,6	4,29	2,4	2,4	2,4	2,4	2,4	
200	150	0,7	4,98	2,4	2,4	2,4	2,4	2,4	
200	200	0,8	5,68	2,4	2,4	2,4	2,4	2,4	
250	100	0,7	4,98	2,4	2,4	2,4	2,4	2,4	
250	150	0,8	5,68	2,4	2,4	2,4	2,4	2,4	
250	200	0,9	6,37	2,4	2,4	2,4	2,4	2,4	
250	250	1,0	7,06	2,4	2,4	2,4	2,4	2,4	
300	100	0,8	5,68	2,4	2,4	2,4	2,4	2,4	
300	150	0,9	6,37	2,4	2,4	2,4	2,4	2,4	
300	200	1,0	7,06	2,4	2,4	2,4	2,4	2,4	
300	250	1,1	7,75	2,4	2,4	2,4	2,4	2,4	
300	300	1,2	8,45	2,4	2,4	2,4	2,4	2,4	
400	100	1,0	7,06	2,4	2,4	2,4	2,4	2,4	
400	150	1,1	7,75	2,4	2,4	2,4	2,4	2,4	
400	200	1,2	8,45	2,4	2,4	2,4	2,4	2,4	
400	250	1,3	9,14	2,4	2,4	2,4	2,4	2,4	
400	300	1,4	9,83	2,4	2,4	2,4	2,4	2,4	
400	400	1,6	11,2	2,4	2,4	2,4	2,4	2,4	
500	150	1,3	9,14	2,4	2,4	2,4	2,4	2,4	
500	200	1,4	9,83	2,4	2,4	2,4	2,4	2,4	
500	250	1,5	10,5	2,4	2,4	2,4	2,4	2,4	
500	300	1,6	11,2	2,4	2,4	2,4	2,4	2,4	
500	400	1,8	12,6	2,4	2,4	2,4	2,4	2,4	
500	500	2,0	14,0	2,4	2,4	2,4	2,4	2,4	
600	150	1,5	10,5	2,4	2,4	2,4	2,4	2,4	
600	200	1,6	11,2	2,4	2,4	2,4	2,4	2,4	
600	250	1,7	11,9	2,4	2,4	2,4	2,4	2,4	
600	300	1,8	12,6	2,4	2,4	2,4	2,4	2,4	
600	400	2,0	14,0	2,4	2,4	2,4	2,4	2,4	
600	500	2,2	15,4	2,4	2,4	2,4	2,4	2,4	
600	600	2,4	16,8	2,4	2,4	2,4	2,4	2,4	
800	200	2,0	14,9	2,4	2,4	2,4	2,4	2,4	
800	250	2,1	15,6	2,4	2,4	2,4	2,4	2,4	
800	300	2,2	16,3	2,4	2,4	2,4	2,4	2,4	
800	400	2,4	17,7	2,4	2,4	2,4	2,4	2,4	
800	500	2,6	19,1	2,4	2,4	2,4	2,4	2,4	
800	600	2,8	20,6	2,4	2,4	2,4	2,4	2,4	
800	800	3,2	25,0	2,4	2,4	2,4	2,4	2,4	

18 19 20 21 22 23 24 25

Duct				Pendulum [type]			
Width	Height	Circumference	Specific weight	Suspension band or mounting bracket	Threaded rod	Suspension band	
				Number of pendulums			
[mm]	[mm]	[m]	[kg/m]	2	2	2	2
				Max. permitted load for each pendulum [N]			
				1700	5000	1200	800
				Point load [N]			
				1000	1000	1000	1000
				Recommended suspension distance			
				[m]	[m]	[m]	[m]
1000	250	2,5	18,6	2,4	2,4	2,4	2,4
1000	300	2,6	19,3	2,4	2,4	2,4	2,4
1000	400	2,8	20,7	2,4	2,4	2,4	2,4
1000	500	3,0	22,1	2,4	2,4	2,4	2,4
1000	600	3,2	23,6	2,4	2,4	2,4	2,4
1000	800	3,6	28,0	2,4	2,4	2,4	2,2
1000	1000	4,0	31,0	2,4	2,4	2,4	2,0
1200	300	3,0	22,3	2,4	2,4	2,4	2,4
1200	400	3,2	23,7	2,4	2,4	2,4	2,4
1200	500	3,4	25,1	2,4	2,4	2,4	2,4
1200	600	3,6	26,6	2,4	2,4	2,4	2,3
1200	800	4,0	31,0	2,4	2,4	2,4	2,0
1200	1000	4,4	34,0	2,4	2,4	2,4	1,8
1200	1200	4,8	37,1	2,4	2,4	2,4	1,6
1400	400	3,6	26,7	2,4	2,4	2,4	2,3
1400	500	3,8	28,1	2,4	2,4	2,4	2,2
1400	600	4,0	29,6	2,4	2,4	2,4	2,1
1400	800	4,4	34,0	2,4	2,4	2,4	1,8
1400	1000	4,8	37,0	2,4	2,4	2,4	1,7
1400	1200	5,2	40,1	2,4	2,4	2,4	1,5
1400	1400	5,6	43,1	2,4	2,4	2,4	1,4
1600	400	4,0	33,4	2,4	2,4	2,4	1,8
1600	500	4,2	34,8	2,4	2,4	2,4	1,8
1600	600	4,4	36,2	2,4	2,4	2,4	1,7
1600	800	4,8	40,8	2,4	2,4	2,4	1,5
1600	1000	5,2	43,8	2,4	2,4	2,4	1,4
1600	1200	5,6	46,8	2,3	2,4	2,4	1,4
1600	1400	6,0	49,8	2,3	2,4	2,4	1,2
1600	1600	6,4	58,0	2,2	2,4	2,4	1,1
1800	500	4,6	38,3	2,4	2,4	2,4	1,6
1800	600	4,8	39,6	2,4	2,4	2,4	1,5
1800	800	5,2	44,3	2,4	2,4	2,4	1,4
1800	1000	5,6	47,3	2,4	2,4	2,4	1,3
1800	1200	6,0	50,3	2,4	2,4	2,4	1,2
1800	1400	6,4	53,3	2,4	2,4	2,4	1,1
1800	1600	6,8	61,5	2,4	2,4	2,3	1,0
1800	1800	7,2	65,0	2,4	2,4	2,2	0,9
2000	500	5,0	40,6	2,4	2,4	2,4	1,5
2000	600	5,2	42,3	2,4	2,4	2,4	1,4
2000	800	5,6	45,5	2,4	2,4	2,4	1,3
2000	1000	6,0	48,7	2,4	2,4	2,4	1,3
2000	1200	6,4	52,0	2,4	2,4	2,4	1,2
2000	1400	6,8	55,3	2,4	2,4	2,4	1,1
2000	1600	7,2	62,1	2,4	2,4	2,3	1,0
2000	1800	7,6	65,3	2,4	2,4	2,2	0,9
2000	2000	8,0	68,5	2,4	2,4	2,1	0,9

Rectangular duct

Insulated EI 15 with wire net mat

Recommended suspension

Fire class R 15

	Product	Number	Specification	Material
Fastening to ceiling	Approved fastener	2		
	Suspension band folded			
	Rectangular washer	2	25 × 25 × 3	Steel
Pendulum between ceiling and duct	Suspension band	1 (2)	25 × 1,25 Ø 10,0 / 8,5 / 3,3	SIS 1311
Fastening to duct bearing section	Suspension band circumferential			
Fire insulation	Wire net mat		40 mm	100 kg/m ³

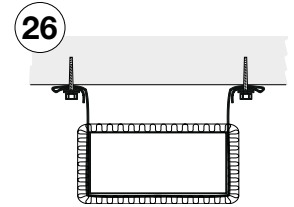

	Product	Number	Specification	Material
Fastening to ceiling	Approved fastener	2		
	Suspension band folded			
	Rectangular washer	2	25 × 25 × 3	Steel
Pendulum between ceiling and duct	Suspension band	2	25 × 1,25 Ø 10,0 / 8,5 / 3,3	SIS 1311
Fastening to duct bearing section	Self-tapping screws or blind rivet	4	4,2 × 13	Steel
	Suspension band screwed/riveted	4	4,0 × 9	Steel
Fire insulation	Wire net mat		40 mm	100 kg/m ³

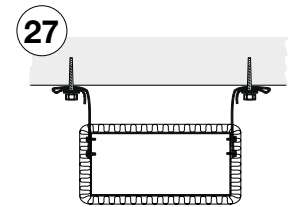

	Product	Number	Specification	Material
Fastening to ceiling	Approved fastener	2		
	Hexagonal nut with flange	2	M8	Steel
	Z bracket	2	25 × 4	Steel
	Hexagonal nut with flange	2	M8	Steel
Pendulum between ceiling and duct	Threaded rod	2	M8	
Fastening to duct bearing section	Hexagonal nut with flange	2	M8	Steel
	Channel (ceiling bracket) or Rail / Channel	1	Height depending on load × min. 3	Steel
		1	Height depending on load × 2-3	Steel
	Hexagonal nut with flange	2	M8	Steel
Fire insulation	Wire net mat		40 mm	100 kg/m ³

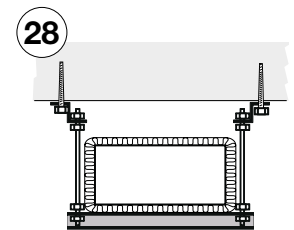

Rectangular duct

Insulated EI 15 with wire net mat

Recommended suspension distance

Fire class R 15

Insulation	product	Wire net mat	
	material	Rock wool	
	density	100	[kg/m ³]
	thickness	40	[mm]
Longest suspension distance		2,4	[m]

Duct				Pendulum [type]	
Width	Height	Circumference	Specific weight	Suspension band	Threaded rod
[mm]	[mm]	[m]	[kg/m]	Number of pendulums	
				2	2
				Max. permitted load for each pendulum [N]	
				500	1000
				Recommended suspension distance	
				[m]	[m]
200	100	0,6	7,33	2,4	2,4
200	150	0,7	8,42	2,4	2,4
200	200	0,8	9,52	2,4	2,4
250	100	0,7	8,42	2,4	2,4
250	150	0,8	9,52	2,4	2,4
250	200	0,9	10,6	2,4	2,4
250	250	1,0	11,7	2,4	2,4
300	100	0,8	9,52	2,4	2,4
300	150	0,9	10,6	2,4	2,4
300	200	1,0	11,7	2,4	2,4
300	250	1,1	12,8	2,4	2,4
300	300	1,2	13,9	2,4	2,4
400	100	1,0	11,7	2,4	2,4
400	150	1,1	12,8	2,4	2,4
400	200	1,2	13,9	2,4	2,4
400	250	1,3	15,0	2,4	2,4
400	300	1,4	16,1	2,4	2,4
400	400	1,6	18,3	2,4	2,4
500	150	1,3	15,0	2,4	2,4
500	200	1,4	16,1	2,4	2,4
500	250	1,5	17,2	2,4	2,4
500	300	1,6	18,3	2,4	2,4
500	400	1,8	20,4	2,4	2,4
500	500	2,0	22,6	2,4	2,4
600	150	1,5	17,2	2,4	2,4
600	200	1,6	18,3	2,4	2,4
600	250	1,7	19,3	2,4	2,4
600	300	1,8	20,4	2,4	2,4
600	400	2,0	22,6	2,4	2,4
600	500	2,2	24,8	2,4	2,4
600	600	2,4	27,0	2,4	2,4
800	200	2,0	23,6	2,4	2,4
800	250	2,1	24,6	2,4	2,4
800	300	2,2	25,7	2,4	2,4
800	400	2,4	27,9	2,4	2,4
800	500	2,6	30,1	2,4	2,4
800	600	2,8	32,4	2,4	2,4
800	800	3,2	38,4	2,4	2,4

Duct				26 27 Pendulum [type]		28
				Suspension band	Threaded rod	
Width				Number of pendulums		
				2	2	
Height				Max. permitted load for each pendulum [N]		
				500	1000	
Circumference				Recommended suspension distance		
				[m]	[m]	
Specific weight				[m]	[m]	
				[mm]	[mm]	[m]
1000	250	2,5	29,2	2,4	2,4	
1000	300	2,6	30,3	2,4	2,4	
1000	400	2,8	32,5	2,4	2,4	
1000	500	3,0	34,7	2,4	2,4	
1000	600	3,2	37,0	2,4	2,4	
1000	800	3,6	43,0	2,4	2,4	
1000	1000	4,0	47,6	2,1	2,4	
1200	300	3,0	34,9	2,4	2,4	
1200	400	3,2	37,1	2,4	2,4	
1200	500	3,4	39,3	2,4	2,4	
1200	600	3,6	41,6	2,4	2,4	
1200	800	4,0	47,6	2,1	2,4	
1200	1000	4,4	52,2	2,0	2,4	
1200	1200	4,8	57,0	1,8	2,4	
1400	400	3,6	41,7	2,4	2,4	
1400	500	3,8	43,9	2,3	2,4	
1400	600	4,0	46,2	2,2	2,4	
1400	800	4,4	52,2	2,0	2,4	
1400	1000	4,8	56,8	1,8	2,4	
1400	1200	5,2	61,6	1,7	2,4	
1400	1400	5,6	66,2	1,5	2,4	
1600	400	4,0	50,0	2,0	2,4	
1600	500	4,2	52,2	2,0	2,4	
1600	600	4,4	54,4	1,9	2,4	
1600	800	4,8	60,7	1,7	2,4	
1600	1000	5,2	65,3	1,6	2,4	
1600	1200	5,6	69,9	1,5	2,4	
1600	1400	6,0	74,5	1,4	2,4	
1600	1600	6,4	84,3	1,2	2,4	
1800	500	4,6	57,3	1,8	2,4	
1800	600	4,8	59,5	1,7	2,4	
1800	800	5,2	65,7	1,6	2,4	
1800	1000	5,6	70,3	1,4	2,4	
1800	1200	6,0	74,9	1,4	2,4	
1800	1400	6,4	79,5	1,3	2,4	
1800	1600	6,8	89,3	1,1	2,3	
1800	1800	7,2	94,4	1,1	2,2	
2000	500	5,0	61,3	1,7	2,4	
2000	600	5,2	63,7	1,6	2,4	
2000	800	5,6	68,5	1,5	2,4	
2000	1000	6,0	73,4	1,4	2,4	
2000	1200	6,4	78,2	1,3	2,4	
2000	1400	6,8	83,2	1,2	2,4	
2000	1600	7,2	91,5	1,1	2,2	
2000	1800	7,6	96,3	1,1	2,1	
2000	2000	8,0	101	1,0	2,0	

Rectangular duct

Insulated EI 15 with board

Recommended suspension

Fire class R 15

	Product	Number	Specification	Material
Fastening to ceiling	Approved fastener	2		
	Suspension band folded			
	Rectangular washer	2	25 × 25 × 3	Steel
Pendulum between ceiling and duct	Suspension band	1 (2)	25 × 1,25 Ø 10,0 / 8,5 / 3,3	SIS 1311
Fastening to duct bearing section	Suspension band circumferential			
Fire insulation	Board		30 mm	150 kg/m ³

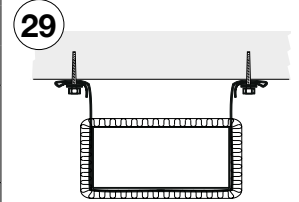

	Product	Number	Specification	Material
Fastening to ceiling	Approved fastener	2		
	Suspension band folded			
	Rectangular washer	2	25 × 25 × 3	Steel
Pendulum between ceiling and duct	Suspension band	2	25 × 1,25 Ø 10,0 / 8,5 / 3,3	SIS 1311
Fastening to duct bearing section	Self-tapping screws or blind rivet	4	4,2 × 13	Steel
	Suspension band screwed/riveted	4	4,0 × 9	Steel
Fire insulation	Board		30 mm	150 kg/m ³

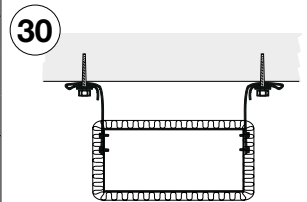

	Product	Number	Specification	Material
Fastening to ceiling	Approved fastener	2		
	Hexagonal nut with flange	2	M8	Steel
	Z bracket	2	25 × 4	Steel
	Hexagonal nut with flange	2	M8	Steel
Pendulum between ceiling and duct	Threaded rod	2	M8	
Fastening to duct bearing section	Hexagonal nut with flange	2	M8	Steel
	Channel (ceiling bracket) or Rail / Channel	1	Height depending on load × min. 3	Steel
		1	Height depending on load × 2-3	Steel
	Hexagonal nut with flange	2	M8	
Fire insulation	Board		30 mm	150 kg/m ³

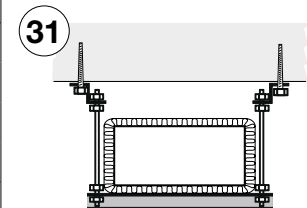

Rectangular duct

Insulated EI 15 with board

Recommended suspension distance

Fire class R 15

Insulation	product	Board	
	material	Rock wool	
	density	150	[kg/m ³]
	thickness	30	[mm]
Longest suspension distance		2,4	[m]

29 30 31

Duct				Pendulum [type]	
Width	Height	Circumference	Specific weight	Suspension band	Threaded rod
				Number of pendulums	
[mm]	[mm]	[m]	[kg/m]	2	2
				Max. permitted load for each pendulum [N]	
				500	1000
				Recommended suspension distance	
				[m]	[m]
200	100	0,6	7,53	2,4	2,4
200	150	0,7	8,67	2,4	2,4
200	200	0,8	9,82	2,4	2,4
250	100	0,7	8,67	2,4	2,4
250	150	0,8	9,82	2,4	2,4
250	200	0,9	11,0	2,4	2,4
250	250	1,0	12,1	2,4	2,4
300	100	0,8	9,82	2,4	2,4
300	150	0,9	11,0	2,4	2,4
300	200	1,0	12,1	2,4	2,4
300	250	1,1	13,2	2,4	2,4
300	300	1,2	14,4	2,4	2,4
400	100	1,0	12,1	2,4	2,4
400	150	1,1	13,2	2,4	2,4
400	200	1,2	14,4	2,4	2,4
400	250	1,3	15,5	2,4	2,4
400	300	1,4	16,7	2,4	2,4
400	400	1,6	19,0	2,4	2,4
500	150	1,3	15,5	2,4	2,4
500	200	1,4	16,7	2,4	2,4
500	250	1,5	17,8	2,4	2,4
500	300	1,6	19,0	2,4	2,4
500	400	1,8	21,2	2,4	2,4
500	500	2,0	23,5	2,4	2,4
600	150	1,5	17,8	2,4	2,4
600	200	1,6	19,0	2,4	2,4
600	250	1,7	20,1	2,4	2,4
600	300	1,8	21,2	2,4	2,4
600	400	2,0	23,5	2,4	2,4
600	500	2,2	25,8	2,4	2,4
600	600	2,4	28,1	2,4	2,4
800	200	2,0	24,5	2,4	2,4
800	250	2,1	25,6	2,4	2,4
800	300	2,2	26,7	2,4	2,4
800	400	2,4	29,0	2,4	2,4
800	500	2,6	31,3	2,4	2,4
800	600	2,8	33,7	2,4	2,4
800	800	3,2	39,9	2,4	2,4

Duct				Pendulum [type]	
				29	30
				Suspension band	Threaded rod
				Number of pendulums	
				2	2
				Max. permitted load for each pendulum [N]	
				500	1000
				Recommended suspension distance	
Width	Height	Circumference	Specific weight	[m]	[m]
[mm]	[mm]	[m]	[kg/m]	[m]	[m]
1000	250	2,5	30,4	2,4	2,4
1000	300	2,6	31,5	2,4	2,4
1000	400	2,8	33,8	2,4	2,4
1000	500	3,0	36,1	2,4	2,4
1000	600	3,2	38,5	2,4	2,4
1000	800	3,6	44,7	2,3	2,4
1000	1000	4,0	49,5	2,1	2,4
1200	300	3,0	36,3	2,4	2,4
1200	400	3,2	38,6	2,4	2,4
1200	500	3,4	40,9	2,4	2,4
1200	600	3,6	43,3	2,4	2,4
1200	800	4,0	49,5	2,1	2,4
1200	1000	4,4	54,3	1,9	2,4
1200	1200	4,8	59,3	1,7	2,4
1400	400	3,6	43,4	2,3	2,4
1400	500	3,8	45,7	2,2	2,4
1400	600	4,0	48,1	2,1	2,4
1400	800	4,4	54,3	1,9	2,4
1400	1000	4,8	59,1	1,7	2,4
1400	1200	5,2	64,1	1,6	2,4
1400	1400	5,6	68,9	1,5	2,4
1600	400	4,0	51,9	2,0	2,4
1600	500	4,2	54,2	1,9	2,4
1600	600	4,4	56,5	1,8	2,4
1600	800	4,8	63,0	1,6	2,4
1600	1000	5,2	67,8	1,5	2,4
1600	1200	5,6	72,6	1,4	2,4
1600	1400	6,0	77,4	1,3	2,4
1600	1600	6,4	87,4	1,2	2,3
1800	500	4,6	59,5	1,7	2,4
1800	600	4,8	61,8	1,6	2,4
1800	800	5,2	68,2	1,5	2,4
1800	1000	5,6	73,0	1,4	2,4
1800	1200	6,0	77,8	1,3	2,4
1800	1400	6,4	82,6	1,2	2,4
1800	1600	6,8	92,6	1,1	2,2
1800	1800	7,2	97,9	1,0	2,1
2000	500	5,0	63,7	1,6	2,4
2000	600	5,2	66,2	1,5	2,4
2000	800	5,6	71,2	1,4	2,4
2000	1000	6,0	76,3	1,3	2,4
2000	1200	6,4	81,0	1,3	2,4
2000	1400	6,8	86,5	1,2	2,4
2000	1600	7,2	95,0	1,1	2,1
2000	1800	7,6	100	1,0	2,0
2000	2000	8,0	105	1,0	1,9

Rectangular duct

Insulated EI 30 with wire net mat

Recommended suspension

Fire class R

	Product	Number	Specification	Material
Fastening to ceiling	Approved fastener	2		
	Suspension band folded Rectangular washer	2	25 × 25 × 3	Steel
Pendulum between ceiling and duct	Suspension band	1 (2)	30 × 1,0 Ø 10,5 / 8,5	SIS 2333
Fastening to duct bearing section	Suspension band circumferential			
Fire insulation	Wire net mat		70 mm	100 kg/m ³

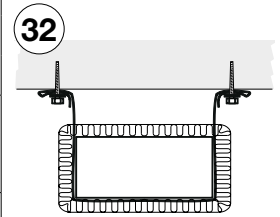

	Product	Number	Specification	Material
Fastening to ceiling	Approved fastener	2		
	Hexagonal nut with flange	2	M8	Steel
	Z bracket	2	25 × 4	Steel
	Hexagonal nut with flange	2	M8	Steel
Pendulum between ceiling and duct	Threaded rod	2	M8	Bright/electro-zinc-plated qual. 4,6
Fastening to duct bearing section	Hexagonal nut with flange	2	M8	Steel
	Channel (ceiling bracket) or Rail / Channel	1	Height depending on load × min. 3	Steel
	Hexagonal nut with flange	1	Height depending on load × 2-3	Steel
Fire insulation	Wire net mat		70 mm	100 kg/m ³

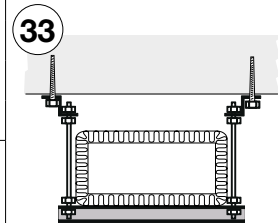

Rectangular duct

Insulated EI 30 with wire net mat

Recommended suspension distance

Fire class R 30

Insulation	product material	Wire net mat	
		Rock wool	
	density	100	[kg/m ³]
	thickness	70	[mm]
Longest suspension distance		2,4	[m]

Duct				32		33	
				Pendulum [type]			
				Suspension band	Threaded rod		
				Number of pendulums			
				2	2		
				Max. permitted load for each pendulum [N]			
				1000	1000		
				Recommended suspension distance			
Width	Height	Circumference	Specific weight	[m]	[m]		
[mm]	[mm]	[m]	[kg/m]		[m]	[m]	
200	100	0,6	10,5	2,4	2,4		
200	150	0,7	11,8	2,4	2,4		
200	200	0,8	13,2	2,4	2,4		
250	100	0,7	11,8	2,4	2,4		
250	150	0,8	13,2	2,4	2,4		
250	200	0,9	14,6	2,4	2,4		
250	250	1,0	16,0	2,4	2,4		
300	100	0,8	13,2	2,4	2,4		
300	150	0,9	14,6	2,4	2,4		
300	200	1,0	16,0	2,4	2,4		
300	250	1,1	17,4	2,4	2,4		
300	300	1,2	18,8	2,4	2,4		
400	100	1,0	16,0	2,4	2,4		
400	150	1,1	17,4	2,4	2,4		
400	200	1,2	18,8	2,4	2,4		
400	250	1,3	20,2	2,4	2,4		
400	300	1,4	21,6	2,4	2,4		
400	400	1,6	24,4	2,4	2,4		
500	150	1,3	20,2	2,4	2,4		
500	200	1,4	21,6	2,4	2,4		
500	250	1,5	23,0	2,4	2,4		
500	300	1,6	24,4	2,4	2,4		
500	400	1,8	27,2	2,4	2,4		
500	500	2,0	29,9	2,4	2,4		
600	150	1,5	23,0	2,4	2,4		
600	200	1,6	24,4	2,4	2,4		
600	250	1,7	25,8	2,4	2,4		
600	300	1,8	27,2	2,4	2,4		
600	400	2,0	29,9	2,4	2,4		
600	500	2,2	32,7	2,4	2,4		
600	600	2,4	35,5	2,4	2,4		
800	200	2,0	30,9	2,4	2,4		
800	250	2,1	32,3	2,4	2,4		
800	300	2,2	33,7	2,4	2,4		
800	400	2,4	36,4	2,4	2,4		
800	500	2,6	39,2	2,4	2,4		
800	600	2,8	42,2	2,4	2,4		
800	800	3,2	49,3	2,4	2,4		

Duct				32		33	
				Pendulum [type]		Pendulum [type]	
				Suspension band		Threaded rod	
				Number of pendulums			
				2		2	
Max. permitted load for each pendulum [N]							
				1000		1000	
Recommended suspension distance							
Width	Height	Circumference	Specific weight				
[mm]	[mm]	[m]	[kg/m]	[m]	[m]	[m]	[m]
1000	250	2,5	38,1	2,4	2,4	2,4	2,4
1000	300	2,6	39,5	2,4	2,4	2,4	2,4
1000	400	2,8	42,2	2,4	2,4	2,4	2,4
1000	500	3,0	45,0	2,4	2,4	2,4	2,4
1000	600	3,2	48,0	2,4	2,4	2,4	2,4
1000	800	3,6	55,1	2,4	2,4	2,4	2,4
1000	1000	4,0	60,9	2,4	2,4	2,4	2,4
1200	300	3,0	45,3	2,4	2,4	2,4	2,4
1200	400	3,2	48,0	2,4	2,4	2,4	2,4
1200	500	3,4	50,8	2,4	2,4	2,4	2,4
1200	600	3,6	53,8	2,4	2,4	2,4	2,4
1200	800	4,0	60,9	2,4	2,4	2,4	2,4
1200	1000	4,4	66,7	2,4	2,4	2,4	2,4
1200	1200	4,8	72,7	2,4	2,4	2,4	2,4
1400	400	3,6	53,8	2,4	2,4	2,4	2,4
1400	500	3,8	56,6	2,4	2,4	2,4	2,4
1400	600	4,0	59,6	2,4	2,4	2,4	2,4
1400	800	4,4	66,7	2,4	2,4	2,4	2,4
1400	1000	4,8	72,5	2,4	2,4	2,4	2,4
1400	1200	5,2	78,5	2,4	2,4	2,4	2,4
1400	1400	5,6	84,3	2,4	2,4	2,4	2,4
1600	400	4,0	63,4	2,4	2,4	2,4	2,4
1600	500	4,2	66,2	2,4	2,4	2,4	2,4
1600	600	4,4	68,9	2,4	2,4	2,4	2,4
1600	800	4,8	76,4	2,4	2,4	2,4	2,4
1600	1000	5,2	82,2	2,4	2,4	2,4	2,4
1600	1200	5,6	88,0	2,3	2,3	2,3	2,3
1600	1400	6,0	93,8	2,2	2,2	2,2	2,2
1600	1600	6,4	105	1,9	1,9	1,9	1,9
1800	500	4,6	72,4	2,4	2,4	2,4	2,4
1800	600	4,8	75,2	2,4	2,4	2,4	2,4
1800	800	5,2	82,7	2,4	2,4	2,4	2,4
1800	1000	5,6	88,5	2,3	2,3	2,3	2,3
1800	1200	6,0	94,3	2,2	2,2	2,2	2,2
1800	1400	6,4	100	2,0	2,0	2,0	2,0
1800	1600	6,8	111	1,8	1,8	1,8	1,8
1800	1800	7,2	117	1,7	1,7	1,7	1,7
2000	500	5,0	77,6	2,4	2,4	2,4	2,4
2000	600	5,2	80,6	2,4	2,4	2,4	2,4
2000	800	5,6	86,7	2,4	2,4	2,4	2,4
2000	1000	6,0	92,7	2,2	2,2	2,2	2,2
2000	1200	6,4	98,7	2,1	2,1	2,1	2,1
2000	1400	6,8	105	1,9	1,9	1,9	1,9
2000	1600	7,2	114	1,8	1,8	1,8	1,8
2000	1800	7,6	120	1,7	1,7	1,7	1,7
2000	2000	8,0	126	1,6	1,6	1,6	1,6

Rectangular duct

Insulated EI 30 with board

Recommended suspension

Fire class R 30

	Product	Number	Specification	Material
Fastening to ceiling	Approved fastener	2		
	Suspension band folded Rectangular washer	2	25 × 25 × 3	Steel
Pendulum between ceiling and duct	Suspension band	1 (2)	30 × 1,0 Ø 10,5 / 8,5	SIS 2333
Fastening to duct bearing section	Suspension band circumferential			
Fire insulation	Board		60 mm	150 kg/m ³

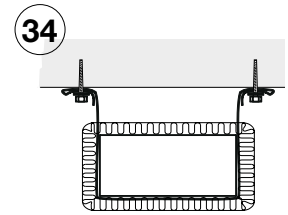

	Product	Number	Specification	Material
Fastening to ceiling	Approved fastener	2		
	Hexagonal nut with flange	2	M8	Steel
	Z bracket	2	25 × 4	Steel
	Hexagonal nut with flange	2	M8	Steel
Pendulum between ceiling and duct	Threaded rod	2	M8	Bright/electro-zinc-plated qual. 4,6
Fastening to duct bearing section	Hexagonal nut with flange	2	M8	Steel
	Channel (ceiling bracket) or Rail / Channel	1	Height depending on load × min. 3	Steel
	Hexagonal nut with flange	1	Height depending on load × 2-3	Steel
Fire insulation	Board		60 mm	150 kg/m ³

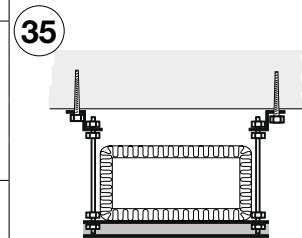

Rectangular duct

Insulated EI 30 with board

Recommended suspension distance

Fire class R 30

Insulation	product material	Board	
		Rock wool	
	density	150	[kg/m ³]
	thickness	60	[mm]
Longest suspension distance		2,4	[m]

Duct				34		35	
				Pendulum [type]		Pendulum [type]	
				Suspension band	Threaded rod		
				Number of pendulums			
				2	2		
				Max. permitted load for each pendulum [N]			
				1000	1000		
				Recommended suspension distance			
Width	Height	Circumference	Specific weight	[m]	[m]		
[mm]	[mm]	[m]	[kg/m]	[m]	[m]		
200	100	0,6	11,9	2,4	2,4		
200	150	0,7	13,4	2,4	2,4		
200	200	0,8	15,0	2,4	2,4		
250	100	0,7	13,4	2,4	2,4		
250	150	0,8	15,0	2,4	2,4		
250	200	0,9	16,6	2,4	2,4		
250	250	1,0	18,2	2,4	2,4		
300	100	0,8	15,0	2,4	2,4		
300	150	0,9	16,6	2,4	2,4		
300	200	1,0	18,2	2,4	2,4		
300	250	1,1	19,8	2,4	2,4		
300	300	1,2	21,4	2,4	2,4		
400	100	1,0	18,2	2,4	2,4		
400	150	1,1	19,8	2,4	2,4		
400	200	1,2	21,4	2,4	2,4		
400	250	1,3	23,0	2,4	2,4		
400	300	1,4	24,6	2,4	2,4		
400	400	1,6	27,8	2,4	2,4		
500	150	1,3	23,0	2,4	2,4		
500	200	1,4	24,6	2,4	2,4		
500	250	1,5	26,2	2,4	2,4		
500	300	1,6	27,8	2,4	2,4		
500	400	1,8	31,0	2,4	2,4		
500	500	2,0	34,1	2,4	2,4		
600	150	1,5	26,2	2,4	2,4		
600	200	1,6	27,8	2,4	2,4		
600	250	1,7	29,4	2,4	2,4		
600	300	1,8	31,0	2,4	2,4		
600	400	2,0	34,1	2,4	2,4		
600	500	2,2	37,3	2,4	2,4		
600	600	2,4	40,5	2,4	2,4		
800	200	2,0	35,1	2,4	2,4		
800	250	2,1	36,7	2,4	2,4		
800	300	2,2	38,3	2,4	2,4		
800	400	2,4	41,4	2,4	2,4		
800	500	2,6	44,6	2,4	2,4		
800	600	2,8	48,0	2,4	2,4		
800	800	3,2	55,9	2,4	2,4		

Duct				34		35	
				Pendulum [type]		Pendulum [type]	
Width				Suspension band		Threaded rod	
				Number of pendulums		Number of pendulums	
Height				2		2	
				Max. permitted load for each pendulum [N]			
Circumference				1000		1000	
				Recommended suspension distance			
Specific weight				[m]		[m]	
[mm]	[mm]	[m]	[kg/m]	[m]	[m]	[m]	[m]
1000	250	2,5	43,3	2,4	2,4	2,4	2,4
1000	300	2,6	44,9	2,4	2,4	2,4	2,4
1000	400	2,8	48,0	2,4	2,4	2,4	2,4
1000	500	3,0	51,2	2,4	2,4	2,4	2,4
1000	600	3,2	54,6	2,4	2,4	2,4	2,4
1000	800	3,6	62,5	2,4	2,4	2,4	2,4
1000	1000	4,0	69,1	2,4	2,4	2,4	2,4
1200	300	3,0	51,5	2,4	2,4	2,4	2,4
1200	400	3,2	54,6	2,4	2,4	2,4	2,4
1200	500	3,4	57,8	2,4	2,4	2,4	2,4
1200	600	3,6	61,2	2,4	2,4	2,4	2,4
1200	800	4,0	69,1	2,4	2,4	2,4	2,4
1200	1000	4,4	75,7	2,4	2,4	2,4	2,4
1200	1200	4,8	82,5	2,4	2,4	2,4	2,4
1400	400	3,6	61,2	2,4	2,4	2,4	2,4
1400	500	3,8	64,4	2,4	2,4	2,4	2,4
1400	600	4,0	67,8	2,4	2,4	2,4	2,4
1400	800	4,4	75,7	2,4	2,4	2,4	2,4
1400	1000	4,8	82,3	2,4	2,4	2,4	2,4
1400	1200	5,2	89,1	2,3	2,3	2,3	2,3
1400	1400	5,6	95,7	2,1	2,1	2,1	2,1
1600	400	4,0	71,6	2,4	2,4	2,4	2,4
1600	500	4,2	74,8	2,4	2,4	2,4	2,4
1600	600	4,4	77,9	2,4	2,4	2,4	2,4
1600	800	4,8	86,2	2,4	2,4	2,4	2,4
1600	1000	5,2	92,8	2,2	2,2	2,2	2,2
1600	1200	5,6	99,4	2,1	2,1	2,1	2,1
1600	1400	6,0	106	1,9	1,9	1,9	1,9
1600	1600	6,4	118	1,7	1,7	1,7	1,7
1800	500	4,6	81,8	2,4	2,4	2,4	2,4
1800	600	4,8	85,0	2,4	2,4	2,4	2,4
1800	800	5,2	93,3	2,2	2,2	2,2	2,2
1800	1000	5,6	100	2,0	2,0	2,0	2,0
1800	1200	6,0	106	1,9	1,9	1,9	1,9
1800	1400	6,4	113	1,8	1,8	1,8	1,8
1800	1600	6,8	125	1,6	1,6	1,6	1,6
1800	1800	7,2	132	1,5	1,5	1,5	1,5
2000	500	5,0	87,8	2,3	2,3	2,3	2,3
2000	600	5,2	91,2	2,2	2,2	2,2	2,2
2000	800	5,6	98,1	2,1	2,1	2,1	2,1
2000	1000	6,0	105	1,9	1,9	1,9	1,9
2000	1200	6,4	112	1,8	1,8	1,8	1,8
2000	1400	6,8	119	1,7	1,7	1,7	1,7
2000	1600	7,2	129	1,6	1,6	1,6	1,6
2000	1800	7,6	136	1,5	1,5	1,5	1,5
2000	2000	8,0	143	1,4	1,4	1,4	1,4

Rectangular duct

Recommended suspension

Insulated EI 60 with wire net mat

Fire class R 60

	Product	Number	Specification	Material
Fastening to ceiling	Approved fastener	2		
	Hexagonal nut with flange	2	M10	Steel
	Z bracket	2	25 × 4	Steel
	Hexagonal nut with flange	2	M10	Steel
Pendulum between ceiling and duct	Threaded rod	2	M10	Bright/electro-zinc-plated qual. 4,6
Fastening to duct bearing section	Hexagonal nut with flange	2	M10	Steel
	Channel (ceiling bracket)	1	Height depending on load × min. 3	Steel
	or Rail / Channel	1	Height depending on load × 2–3	Steel
	Hexagonal nut with flange	2	M10	Steel
Fire insulation	Wire net mat		140 mm	100 kg/m ³

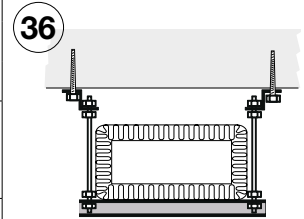

Rectangular duct

Insulated EI 60 with wire net mat

Recommended suspension distance

Fire class R 60

Insulation	product material	Wire net mat Rock wool	
	density	100	[kg/m ³]
	thickness	140	[mm]
Longest suspension distance		2,4	[m]

36

Duct				Pendulum [type]
Width	Height	Circumference	Specific weight	Threaded rod
[mm]	[mm]	[m]	[kg/m]	Number of pendulums
				2
				Max. permitted load for each pendulum [N]
				1000
				Recommended suspension distance [m]
200	100	0,6	20,5	2,4
200	150	0,7	22,6	2,4
200	200	0,8	24,7	2,4
250	100	0,7	22,6	2,4
250	150	0,8	24,7	2,4
250	200	0,9	26,8	2,4
250	250	1,0	28,9	2,4
300	100	0,8	24,7	2,4
300	150	0,9	26,8	2,4
300	200	1,0	28,9	2,4
300	250	1,1	31,0	2,4
300	300	1,2	33,1	2,4
400	100	1,0	28,9	2,4
400	150	1,1	31,0	2,4
400	200	1,2	33,1	2,4
400	250	1,3	35,2	2,4
400	300	1,4	37,3	2,4
400	400	1,6	41,5	2,4
500	150	1,3	35,2	2,4
500	200	1,4	37,3	2,4
500	250	1,5	39,4	2,4
500	300	1,6	41,5	2,4
500	400	1,8	45,6	2,4
500	500	2,0	49,8	2,4
600	150	1,5	39,4	2,4
600	200	1,6	41,5	2,4
600	250	1,7	43,5	2,4
600	300	1,8	45,6	2,4
600	400	2,0	49,8	2,4
600	500	2,2	54,0	2,4
600	600	2,4	58,2	2,4
800	200	2,0	50,8	2,4
800	250	2,1	52,8	2,4
800	300	2,2	54,9	2,4
800	400	2,4	59,1	2,4
800	500	2,6	63,3	2,4
800	600	2,8	67,6	2,4
800	800	3,2	77,6	2,4

36

Duct				Pendulum [type] Threaded rod
Width	Height	Circumference	Specific weight	Number of pendulums 2
[mm]	[mm]	[m]	[kg/m]	Max. permitted load for each pendulum [N] 1000
				Recommended suspension distance [m]
1000	250	2,5	61,4	2,4
1000	300	2,6	63,5	2,4
1000	400	2,8	67,7	2,4
1000	500	3,0	71,9	2,4
1000	600	3,2	76,2	2,4
1000	800	3,6	86,2	2,4
1000	1000	4,0	94,8	2,2
1200	300	3,0	72,1	2,4
1200	400	3,2	76,3	2,4
1200	500	3,4	80,5	2,4
1200	600	3,6	84,8	2,4
1200	800	4,0	94,8	2,2
1200	1000	4,4	103	2,0
1200	1200	4,8	112	1,8
1400	400	3,6	84,9	2,4
1400	500	3,8	89,1	2,3
1400	600	4,0	93,4	2,2
1400	800	4,4	103	2,0
1400	1000	4,8	112	1,8
1400	1200	5,2	121	1,7
1400	1400	5,6	129	1,6
1600	400	4,0	97,2	2,1
1600	500	4,2	101	2,0
1600	600	4,4	106	1,9
1600	800	4,8	116	1,8
1600	1000	5,2	124	1,6
1600	1200	5,6	133	1,5
1600	1400	6,0	142	1,4
1600	1600	6,4	155	1,3
1800	500	4,6	110	1,8
1800	600	4,8	115	1,8
1800	800	5,2	125	1,6
1800	1000	5,6	134	1,5
1800	1200	6,0	142	1,4
1800	1400	6,4	151	1,4
1800	1600	6,8	165	1,2
1800	1800	7,2	174	1,2
2000	500	5,0	118	1,7
2000	600	5,2	123	1,7
2000	800	5,6	132	1,5
2000	1000	6,0	141	1,5
2000	1200	6,4	149	1,4
2000	1400	6,8	158	1,3
2000	1600	7,2	171	1,2
2000	1800	7,6	180	1,1
2000	2000	8,0	188	1,1

Rectangular duct

Insulated EI 60 with board

Recommended suspension

Fire class R 60

	Product	Number	Specification	Material
Fastening to ceiling	Approved fastener	2		
	Hexagonal nut with flange	2	M10	Steel
	Z bracket	2	25 × 4	Steel
	Hexagonal nut with flange	2	M10	Steel
Pendulum between ceiling and duct	Threaded rod	2	M10	Bright/electro-zinc-plated qual. 4,6
Fastening to duct bearing section	Hexagonal nut with flange	2	M10	Steel
	Channel (ceiling bracket)	1	Height depending on load × min. 3	Steel
	or Rail / Channel	1	Height depending on load × 2-3	Steel
	Hexagonal nut with flange	2	M10	Steel
Fire insulation	Board		120 mm	150 kg/m ³

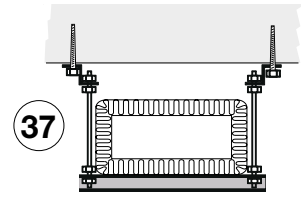

Rectangular duct

Insulated EI 60 with board

Recommended suspension distance

Fire class R 60

Insulation	product material	Board Rock wool	
	density	150	[kg/m ³]
	thickness	120	[mm]
Longest suspension distance		2,4	[m]

37

Duct				Pendulum [type]
Width	Height	Circumference	Specific weight	Threaded rod
[mm]	[mm]	[m]	[kg/m]	Number of pendulums
				2
				Max. permitted load for each pendulum [N]
				1000
				Recommended suspension distance [m]
200	100	0,6	23,7	2,4
200	150	0,7	26,2	2,4
200	200	0,8	28,7	2,4
250	100	0,7	26,2	2,4
250	150	0,8	28,7	2,4
250	200	0,9	31,2	2,4
250	250	1,0	33,7	2,4
300	100	0,8	28,7	2,4
300	150	0,9	31,2	2,4
300	200	1,0	33,7	2,4
300	250	1,1	36,2	2,4
300	300	1,2	38,7	2,4
400	100	1,0	33,7	2,4
400	150	1,1	36,2	2,4
400	200	1,2	38,7	2,4
400	250	1,3	41,2	2,4
400	300	1,4	43,7	2,4
400	400	1,6	48,7	2,4
500	150	1,3	41,2	2,4
500	200	1,4	43,7	2,4
500	250	1,5	46,2	2,4
500	300	1,6	48,7	2,4
500	400	1,8	53,6	2,4
500	500	2,0	58,6	2,4
600	150	1,5	46,2	2,4
600	200	1,6	48,7	2,4
600	250	1,7	51,1	2,4
600	300	1,8	53,6	2,4
600	400	2,0	58,6	2,4
600	500	2,2	63,6	2,4
600	600	2,4	68,6	2,4
800	200	2,0	59,6	2,4
800	250	2,1	62,0	2,4
800	300	2,2	64,5	2,4
800	400	2,4	69,5	2,4
800	500	2,6	74,5	2,4
800	600	2,8	79,6	2,4
800	800	3,2	91,2	2,2

37

Duct				Pendulum [type] Threaded rod
				Number of pendulums 2
Width	Height	Circumference	Specific weight	Max. permitted load for each pendulum [N] 1000
[mm]	[mm]	[m]	[kg/m]	Recommended suspension distance [m]
1000	250	2,5	72,2	2,4
1000	300	2,6	74,7	2,4
1000	400	2,8	79,7	2,4
1000	500	3,0	84,7	2,4
1000	600	3,2	89,8	2,3
1000	800	3,6	101	2,0
1000	1000	4,0	112	1,8
1200	300	3,0	84,9	2,4
1200	400	3,2	89,9	2,3
1200	500	3,4	94,9	2,1
1200	600	3,6	100	2,0
1200	800	4,0	112	1,8
1200	1000	4,4	122	1,7
1200	1200	4,8	132	1,5
1400	400	3,6	100	2,0
1400	500	3,8	105	1,9
1400	600	4,0	110	1,8
1400	800	4,4	122	1,7
1400	1000	4,8	132	1,5
1400	1200	5,2	142	1,4
1400	1400	5,6	153	1,3
1600	400	4,0	114	1,8
1600	500	4,2	119	1,7
1600	600	4,4	124	1,6
1600	800	4,8	136	1,5
1600	1000	5,2	146	1,4
1600	1200	5,6	156	1,3
1600	1400	6,0	166	1,2
1600	1600	6,4	182	1,1
1800	500	4,6	130	1,6
1800	600	4,8	135	1,5
1800	800	5,2	147	1,4
1800	1000	5,6	157	1,3
1800	1200	6,0	167	1,2
1800	1400	6,4	177	1,2
1800	1600	6,8	193	1,1
1800	1800	7,2	203	1,0
2000	500	5,0	139	1,5
2000	600	5,2	145	1,4
2000	800	5,6	155	1,3
2000	1000	6,0	165	1,2
2000	1200	6,4	176	1,2
2000	1400	6,8	186	1,1
2000	1600	7,2	200	1,0
2000	1800	7,6	211	1,0
2000	2000	8,0	221	0,9



At Lindab we simplify construction for our customers. We do that by designing easy-to-use products and solutions, as well as offering efficient availability and logistics. We are also working on ways to reduce our impact on our environment and climate. We do that by developing methods to produce our solutions using a minimum of energy and natural resources, and by reducing negative effects on the environment. We use steel in our products. It's one of few materials that can be recycled an infinite number of times without losing any of its properties. That means less carbon emissions in nature and less energy wasted.

We simplify construction

